



# Test Plan for Wireless Device Over-the-Air Performance

---

## CTIA 01.71, Device Setup and Positioning Guidelines

Version 7.0.0

April 2024

**© 2001 - 2024 CTIA Certification. All Rights Reserved.**

Any reproduction, modification, alteration, creation of a derivative work, or transmission of all or any part of this publication ("Test Plan"), in any form, by any means, whether electronic or mechanical, including photocopying, recording, or via any information storage and retrieval system, without the prior written permission of CTIA Certification, is unauthorized and strictly prohibited by federal copyright law. This Test Plan is solely for use within the CTIA Certification Program. Any other use of this Test Plan is strictly prohibited unless authorized by CTIA Certification or its assigns in writing.

## Use Instructions

All testing shall be performed in a CTIA Certification Authorized Test Lab and shall be initiated through one of the following methods:

1. By submitting a PTCRB or IoT Network Certified device certification request at <https://certify.ptcrb.com/>
2. By submitting an OTA Test Plan use request at <https://certify.ctiacertification.org/>

CTIA Certification LLC  
1400 16th Street, NW  
Suite 600  
Washington, DC 20036

1.202.785.0081

[programs@ctiacertification.org](mailto:programs@ctiacertification.org)

[ctiacertification.org/test-plans/](https://ctiacertification.org/test-plans/)

# Table of Contents

Section 1	Introduction .....	7
1.1	Purpose .....	7
1.2	Scope.....	7
1.3	Acronyms and Definitions .....	7
1.4	Document References .....	8
Section 2	Generic Test Set-up Configurations .....	9
2.1	Positioning Requirements and Coordinate Systems .....	9
2.2	Positioning Requirements Hand-Held Devices .....	9
2.2.1	Free-Space .....	9
2.2.2	Head Phantom Only .....	11
2.2.3	Head and Hand Phantom (“Talk Mode”) .....	14
2.2.4	Mounting Monoblock DUT in Monoblock Hand Phantom for Talk Mode .....	17
2.2.5	Mounting Fold DUT in Fold Hand Phantom for Talk Mode .....	19
2.2.6	Mounting Wide DUT in PDA Hand Phantom for Talk Mode.....	21
2.2.7	Mounting a Wide DUT in the Wide Grip Hand Phantom for Talk Mode .....	23
2.2.8	Hand Phantom Only .....	26
2.2.9	Mounting a Narrow DUT in the Narrow Hand Phantom for Data Mode .....	28
2.2.10	Mounting a Wide DUT in the PDA Phantom for Data Mode.....	29
2.2.11	Mounting a Wide DUT in the Wide Grip Phantom for Data Mode .....	30
2.3	Positioning and Setup Requirements for Wrist-Worn Devices.....	30
2.3.1	Positioning of Wrist-Worn DUT Relative to the Chamber Coordinate System.....	30
2.3.2	Mounting a Wrist-Worn DUT on the Forearm Phantom .....	31
2.4	Positioning and Setup Guidelines for Chest-Worn Devices .....	40
2.4.1	Positioning of Chest-Worn DUT Relative to the Chamber Coordinate System.....	40
2.4.2	Mounting a Chest-Worn DUT on the Chest Phantom .....	41
2.5	Positioning and Setup Guidelines for Ankle-Worn Devices .....	42
2.5.1	Positioning of Ankle-Worn DUT Relative to the Chamber Coordinate System .....	43
2.5.2	Mounting an Ankle-Worn DUT on the Ankle Phantom .....	43
2.6	Positioning Requirements Notebook and Tablet .....	45
2.6.1	Device Under Test – Setup .....	45
2.6.1.1	Free Space Test Fixture .....	46
2.6.2	Chamber Placement .....	46
2.6.3	Positioning a Notebook Relative to the Chamber Coordinate System .....	46
2.6.3.1	Distributed Axes, Conical Cut Chamber .....	47
2.6.3.2	Combined-Axes, Great Circle Chamber .....	47
2.6.4	Positioning a Tablet Relative to the Chamber Coordinate System .....	48
2.6.4.1	Distributed Axes, Conical Cut Chamber .....	50

2.6.4.2	Combined-Axis, Great Circle Chamber.....	50
2.7	Positioning Requirements Integrated Device .....	50
2.7.1	Device Under Test – Setup .....	50
2.7.2	Free Space Fixturing .....	51
2.7.3	Considerations for Externally-powered Devices.....	51
2.7.4	Integrated Device Chamber Placement.....	52
2.7.5	Positioning an Integrated Device Relative to the Chamber Coordinate System .....	53
2.7.6	Positioning an Integrated Device with a Removable Antenna Connected Directly to the Device via an RF Transmission Line (Such as a Coaxial Cable) Less Than 20 cm in Length .....	54
Section 3	MIMO Chamber Specific DUT Orientation Conditions .....	55
3.1	Scope.....	55
3.2	Testing Environment Conditions.....	55
3.3	DUT Positioning within the MPAC Test Volume.....	57
3.3.1	DUT Free-Space Orientation within the MPAC Test Zone.....	57
3.3.2	MPAC DUT Orientation within the Test Zone using Phantoms.....	57
3.3.3	Maximum DUT Antenna Spacing and Placement of DUT within the Test Zone .....	58
3.3.3.1	DUT Placement, Frequency of Operation < 1GHz .....	59
3.3.3.2	DUT Placement, Frequency of Operation > 1GHz .....	59
3.4	DUT Positioning within the RTS Test Volume.....	61
3.4.1	DUT Free-Space Orientation within the RTS Test Zone.....	61
3.4.2	RTS DUT Orientation within the Test Zone using Phantoms .....	61
3.4.3	Maximum DUT Antenna Spacing and Placement of DUT within the Test Zone .....	61
3.5	MIMO Chamber Specific DUT Orientation Conditions (Informative).....	61
3.5.1	Scope 61	
3.5.2	Testing Environment Conditions.....	61
Section 4	SISO, Millimeter Wave Test Setup Configurations.....	66
4.1	Millimeter Wave Positioning Requirements and Reference Coordinate System .....	66
Section 5	SISO, Reverberation Chamber Test Setup Configurations.....	82
5.1	DUT and Reference Antenna Location within the Test Volume.....	82
5.2	DUT Free Space Positioning Requirements .....	82
5.3	DUT Positioning Requirements on Phantoms .....	82
Appendix A	Revision History.....	84

## List of Figures

Figure 2.2.1-1 DUT Vertical and Horizontal Reference Lines.....	10
Figure 2.2.1-2 DUT Coordinate System - Free Space.....	11
Figure 2.2.2-1 SAM Head Phantom with Mouth and Ear Locations .....	12
Figure 2.2.2-2 DUT Position: “Cheek” or “Touch” Positions for Right Ear .....	13
Figure 2.2.2-3 Definition of Coordinate System for SAM Head Phantom.....	13
Figure 2.2.2-4 Alternate Coordinate System for SAM Head Phantom .....	14
Figure 2.2.3-1 Optional Head Phantom Mask Spacer on SAM Head Phantom .....	15
Figure 2.2.3-2 Head and Hand Configuration (A) With and (B) Without Mask Spacer (Right), (C) With and (D) Without Mask Spacer (Left) .....	17
Figure 2.2.4-1 Alignment Tool A .....	18
Figure 2.2.4-2 Monoblock Palm Spacer.....	19
Figure 2.2.5-1 Alignment Tool B and Usage with Fold DUT .....	20
Figure 2.2.5-2 Usage of Alignment Tool B with Open Portrait Slide DUT .....	20
Figure 2.2.5-3 Fold Palm Spacer .....	21
Figure 2.2.6-1 PDA Palm Spacer.....	22
Figure 2.2.6-2 Positioning of Wide DUT with Respect to PDA Palm Spacer .....	23
Figure 2.2.7-1 Wide Grip Hand Phantom Contact Points .....	24
Figure 2.2.7-2 Wide Grip Palm Spacer Contact Surfaces .....	24
Figure 2.2.7-3 Insulating Grommet to Prevent Side Key Actuation .....	25
Figure 2.2.7-4 Wide Grip DUT Positioning Example With Rounded Corner, Side Key Grommet.....	26
Figure 2.2.8-1 DUT Display Alignment Features .....	27
Figure 2.2.8-2 Definition of Coordinate System for DUT with Hand Phantom in Data Mode .....	28
Figure 2.2.9-1 Measuring a Narrow DUT in Alignment Tool A for Hand Only (“Data Mode”) Testing.....	29
Figure 2.2.9-2 Narrow Data Palm Spacer.....	29
Figure 2.3.1-1 Cartesian Coordinate System for Forearm Phantom .....	31
Figure 2.3.2-1 Definition of Plane <i>J</i> and Plane <i>K</i> on the Forearm Phantom .....	32
Figure 2.3.2-2 Local Coordinate System for a Wrist-Worn Device .....	33

Figure 2.3.2-3 Definition of Plane A and Plane B on a Wrist-Worn Device .....	34
Figure 2.3.2-4 Alignment of Plane A with Plane K and Plane B with Plane J when a Wrist-Worn Device, which can be Laid Out Flat, Is Mounted on the Forearm Phantom.....	35
Figure 2.3.2-5 Alignment of Plane A with Plane K and Plane B with Plane J when a Wrist-Worn Device with a Pre-Formed Wrist Band Is Mounted on the Forearm Phantom .....	35
Figure 2.3.2-6 Location of Plane B on a Wrist-Worn Device with a Symmetric Pre-Formed Shape.....	36
Figure 2.3.2-7 Examples of Correctly Mounting the Device on the Forearm Phantom by Keeping the Main Module Parallel to the Surface of the Forearm Phantom .....	37
Figure 2.3.2-8 Example of Incorrectly Mounting the Device on the Forearm Phantom by not Keeping the Main Module Parallel to the Surface of the Forearm Phantom .....	38
Figure 2.3.2-9 Two Orientations of DUT On Forearm Phantom Representing the Left and Right Wrist...	39
Figure 2.4.1-1 Cartesian Coordinate System for Chest Phantom .....	41
Figure 2.5.1-1 Cartesian Coordinate System for Ankle Phantom.....	43
Figure 2.5.2-1 Definition of Plane J and Plane K on the Ankle Phantom .....	44
Figure 2.6.3-1 Position of Notebook Relative to the Chamber Coordinates.....	47
Figure 2.6.4-1 Position of Tablet Relative to the Chamber Coordinates .....	49
Figure 2.7.5-1 Internal Antenna .....	53
Figure 2.7.5-2 Direct Connect External Antenna (It does not matter where the antenna is located as you will center on the device).....	53
Figure 3.2-1 Reference Device Orientation .....	55
Figure 3.2-2 Left and Right Tilts for Landscape Mode Relative to Portrait Mode Shown to Interact Differently with the Antennas Depending on the Tilt .....	56
Figure 3.3.3-1: Illustration of DUT Antenna Spacing and Positioning Guidelines, (a) Guideline in this Test Plan, (b) Example with DUT Meeting the Maximum Allowed Antenna Separation but not Within the Verified Power Stability Region .....	58
Figure 4.1-1 Reference Coordinate System .....	66
Figure 4.1-2 Millimeter-Wave DUT Re-Positioning for an Example of Distributed-Axes System.....	79
Figure 4.1-3 DUT Re-Positioning for an Example of Combined-Axes System.....	79
Figure 4.1-4: Gray-Box Test Approach.....	80
Figure 4.1-5: Black-Box Test Approach .....	81

## List of Tables

Table 3.2-1 Normative Testing Environment conditions for Devices Supporting DL MIMO Data Reception .....	56
Table 3.5.2-1 Informative Testing Environment conditions for MIMO OTA Testing Using Principal Antenna Pattern Cuts.....	63
Table 3.5.2-2 Informative Testing Environment conditions for Devices Supporting DL MIMO Data Reception While Using Hand Phantoms .....	64
Table 3.5.2-3 Informative Testing Environment conditions for Notebook Devices Supporting DL MIMO Data Reception.....	65
Table 4.1-1 Millimeter-Wave DUT Test Conditions and Angle Definitions for Smartphones and Tablets for Alignment Option 1 .....	67
Table 4.1-2 Millimeter-Wave DUT Test Conditions and Angle Definitions for Smartphones and Tablets for Alignment Option 2.....	68
Table 4.1-3 Millimeter-Wave DUT Test Conditions and Angle Definitions for Smartphones and Tablets for Alignment Option 3.....	69

## Section 1 Introduction

### 1.1 Purpose

The purpose of this document is to define the positioning guidelines used in OTA testing.

### 1.2 Scope

This document defines general requirements for the positioning of wireless devices to ensure the accurate, repeatable, and uniform OTA testing.

### 1.3 Acronyms and Definitions

The following specialized terms and acronyms are used throughout this document.

Table 1.3-1 Acronyms and Definitions

Acronym/Term	Definition
ATL	Authorized Test Lab
CPU	Central Processing Unit
DL	Down Link
DML	Data Mode-Landscape
DMP	Data Mode-Portrait
DMSU	Data Mode Screen Up
DUT	Device Under Test
EIRP	Effective Isotropic Radiated Power
EIS	Effective Isotropic Sensitivity
LCD	Liquid Crystal Display
LE	Left Ear
M	Mouth
MIMO	Multiple Input Multiple Output
MPAC	Multi-Probe Anechoic Chamber utilized for the assessment of MIMO-capable devices.
OTA	Over The Air
PDA	Personal Digital Assistant
RE	Right Ear
RTS	Radiated Two Stage



Acronym/Term	Definition
SAM	Specific Anthropomorphic Mannequin
SISO	Single Input Single Output
TIS	Total Isotropic Sensitivity
TRP	Total Radiated Power
UWB	Ultra-Wide Band
VoLTE	Voice over LTE
WLAN	Wireless Local Area Network
WWAN	Wireless Wide Area Network

#### 1.4 Document References

The following documents are referenced in this test plan:

Document Number, Document Name
[1] CTIA 01.01, <i>Test Scope, Requirements, and Applicability</i>
[2] CTIA 01.73, <i>Supporting Procedures</i>
[3] CTIA 01.70, <i>Measurement Uncertainty</i>
[4] B. Yanakiev, J. Nielsen, M. Christensen, G. Pedersen: <i>Antennas in Real Environments</i> , EuCAP, 2011
[5] CTIA 01.40, <i>Test Methodology, MIMO, Anechoic Chamber</i>
[6] CTIA 01.21, <i>Test Methodology SISO Reverberation Chamber (Informative)</i>
[7] IEEE 149-1979.R2008

## Section 2      Generic Test Set-up Configurations

This section defines the required orientation of the DUT and any required phantoms relative to a Cartesian (XYZ) coordinate system and illustrates the starting orientation of that coordinate system for the typical spherical measurement systems (distributed or combined axes). It also includes schematics of typical instrumentation configurations. Alternate setups are allowed as long as they meet the criteria specified in this Test Plan and any additional uncertainty contributions are accounted for. The general requirement is that the test setup be capable of holding the DUT in any configuration suitable to its use case (see *CTIA 01.01* [1]). The performance of the test site must be determined as detailed in *CTIA 01.73* [2].

### 2.1      Positioning Requirements and Coordinate Systems

The test system must be capable of holding the DUT and any associated phantoms (defined in this section). The hardware and positioners used to accomplish this must be made of low dielectric material (dielectric constant less than 5.0 and a loss tangent less than 0.05) so as to produce a minimal impact on overall measurement uncertainty. The measurement uncertainty due to any components not included in the ripple test shall be assessed according to *CTIA 01.70* [3]. As the DUT could be held in multiple configurations (free space, head and hand phantom [left and right], hand phantom only [left and right]), considerable care must be given to the design and implementation of the DUT holding fixtures so as to meet all of these requirements.

All of the fixtures and tools referenced shall be fabricated using the CAD files obtained from CTIA. Contact [cpwg@ctiacertification.org](mailto:cpwg@ctiacertification.org) to obtain CAD files.

While different spherical measurement systems may require a different starting orientation of the DUT, the relative coordinate system for the DUT and phantoms shall remain the same independent of test site implementation.

The following subsections detail the positioning requirements and coordinate systems for the various required test configurations.

### 2.2      Positioning Requirements Hand-Held Devices

#### 2.2.1    Free-Space

The “free-space” position and coordinate system are defined as follows:

1. Ready the DUT for operation, if necessary.
2. Define two imaginary lines on the DUT: the vertical centerline and the horizontal line. The vertical centerline passes through two points on the front side of the DUT: the midpoint of the width  $w_t$  of the DUT at the level of the earpiece (point A on [Figure 2.2.1-1](#)) and the midpoint of the width  $w_b$  of the bottom of the DUT (point B). The horizontal line is perpendicular to the vertical centerline and passes through the center of the earpiece (see [Figure 2.2.1-1](#)). The two lines intersect at point A. Note that for many DUT's, point A coincides with the center of the earpiece, however, the earpiece may be located elsewhere on the horizontal line. Also note that the vertical centerline is not necessarily parallel to the front face of the DUT (see [Figure 2.2.1-1](#)), especially for fold DUT's, DUT's with flip pieces, and other irregularly-shaped DUT's.
3. Define a Cartesian coordinate system with the origin at point A, where the positive Z-axis is along the line from B to A, the positive Y-axis is along the horizontal line and points to the “right” of the phone face, and the positive X-axis is orthogonal to the Y-Z plane and points away from the face of the phone. [Figure 2.2.1-2](#) illustrates this coordinate system

definition for three typical case styles of DUT. In all cases, the longitudinal direction of the DUT is the Z-axis, and the right hand rule is used to define the X- and Y-axes.

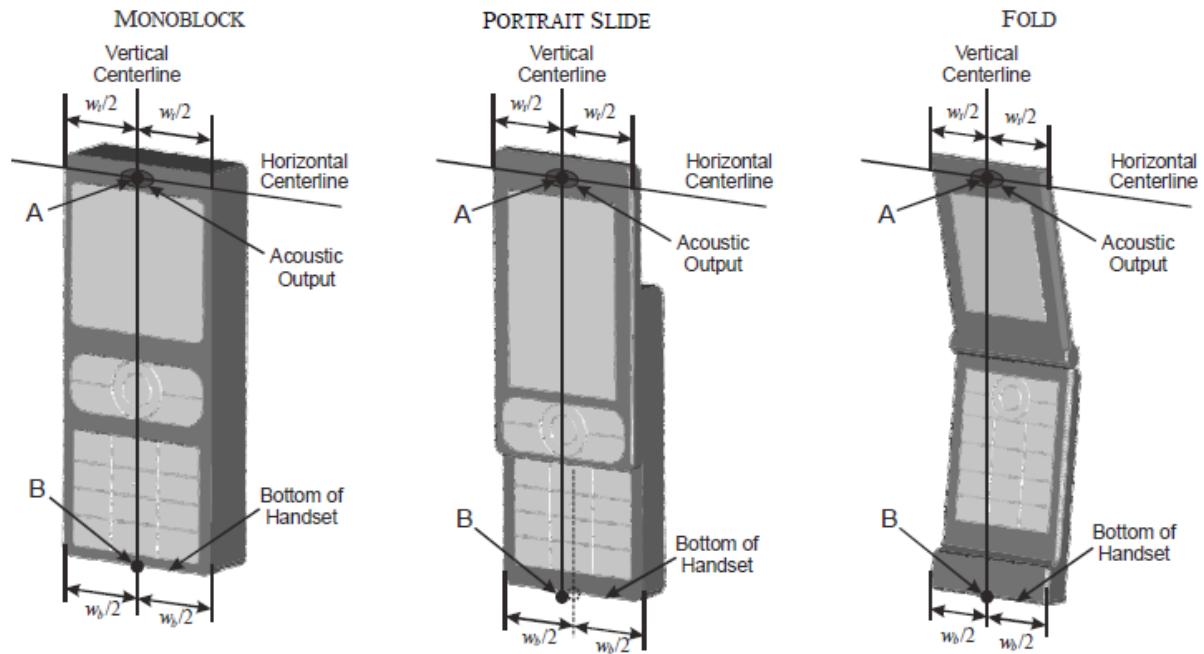

Figure 2.2.1-1 DUT Vertical and Horizontal Reference Lines

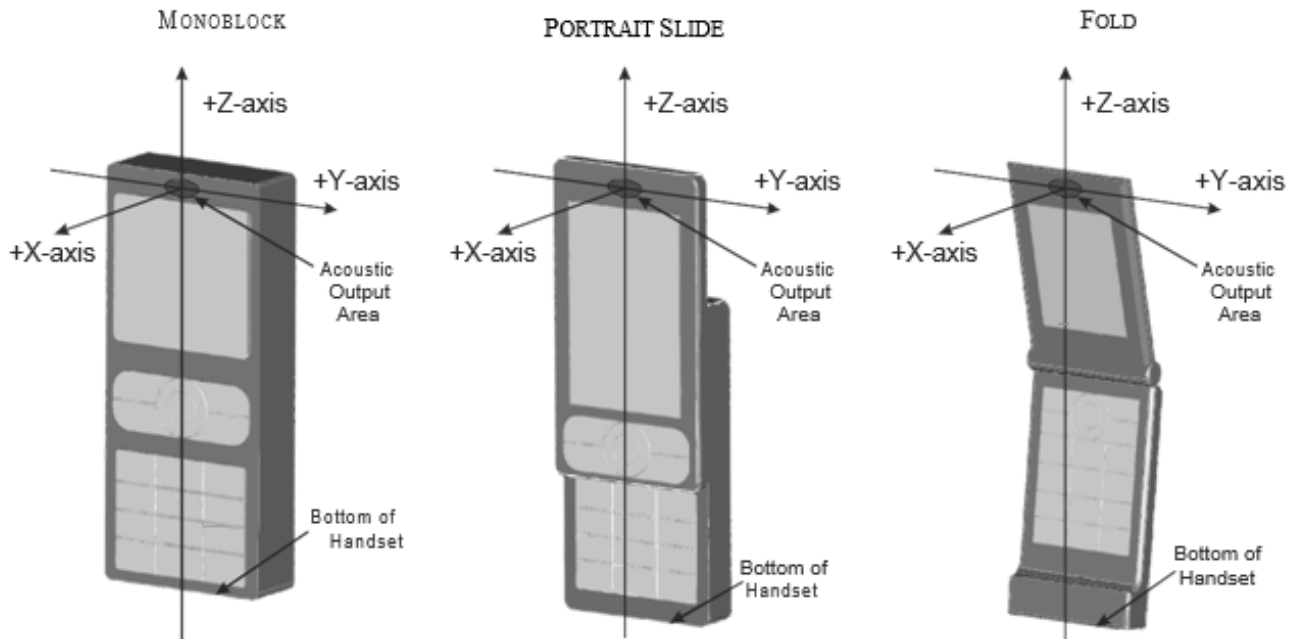

Figure 2.2.1-2 DUT Coordinate System - Free Space

Note that monoblock DUTs are also referred to as candy bar phones. Fold DUTs are also referred to as clam shell phones.

### 2.2.2 Head Phantom Only

The head phantom only configuration is used to simulate talk position, in cases for which no standard hand phantom is available (see Section 2.1.2.1.1 of *CTIA 01.01 [1]*).

The DUT shall be mounted in “cheek” position on the head phantom. This position and its coordinate system are defined as follows:

1. Follow steps 1 and 2 from section 2.2.1.
2. Figure 2.2.2-1 shows the profile of the SAM head phantom. Indicated are the locations of the right ear (RE) point and the mouth (M). The corresponding left ear point (LE) being on the head phantom's corresponding left side. Position the DUT close to the surface of the SAM head phantom such that point A is on the (virtual) extension of the line passing through points RE and LE on the head phantom (see Figure 2.2.2-2), and so that the plane defined by the vertical center and the horizontal line of the phone is approximately parallel to the sagittal plane of the head phantom.
3. Translate the DUT towards the head phantom along the line passing through RE and LE until the DUT touches the ear.
4. While maintaining the DUT in this plane, rotate it around the LE-RE line until the vertical centerline is in the plane normal to MB-NF including the line MB (called the reference plane).
5. Rotate the DUT around the vertical centerline until the phone (horizontal line) is symmetrical with respect to the line NF.

6. While maintaining the vertical centerline in the reference plane, keeping point A on the line passing through RE and LE and maintaining the DUT contact with the ear, rotate the DUT about the line NF until any point on the DUT is in contact with a head phantom point below the ear (cheek). See [Figure 2.2.2-2](#).
7. Define a Cartesian coordinate system with the origin at point A (RE or LE), where the positive Z-axis is perpendicular to the top of the SAM head phantom, the positive X-axis pointing away from the face of the phantom, and the positive Y-axis along the RE-LE line in the LE direction. [Figure 2.2.2-3](#) illustrates this coordinate system definition both the right and left ears. As an alternative, the origin of the coordinate system may be moved along the Y-axis while maintaining the orientation of the coordinate system such that the X-Z plane is in the center of the phantom as illustrated in [Figure 2.2.2-4](#) provided the uncertainty contribution in Section 2.9.1.1 of *CTIA 01.70* [3] is applied.

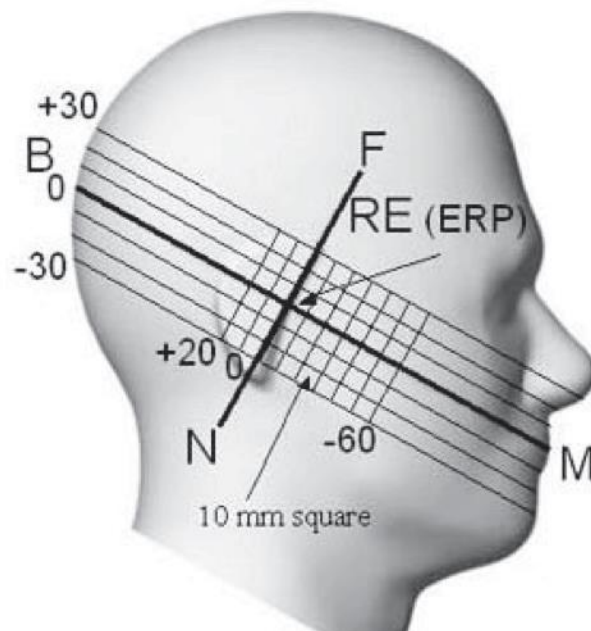

Figure 2.2.2-1 SAM Head Phantom with Mouth and Ear Locations

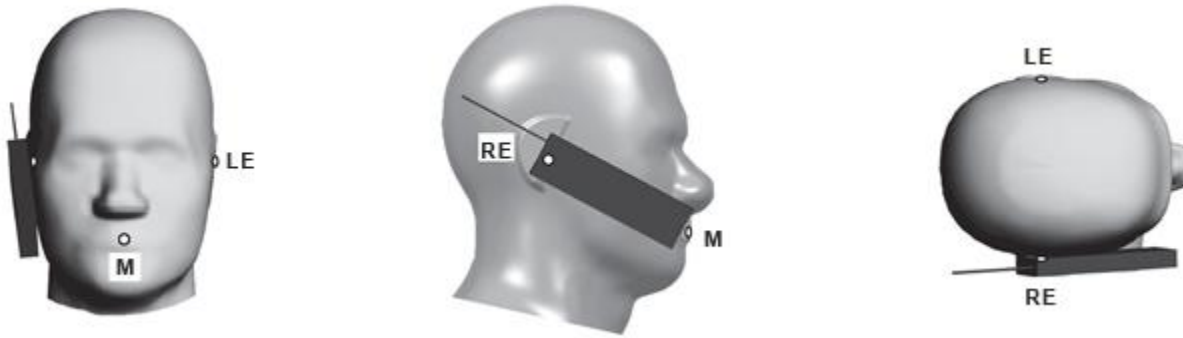

Figure 2.2.2-2 DUT Position: “Cheek” or “Touch” Positions for Right Ear

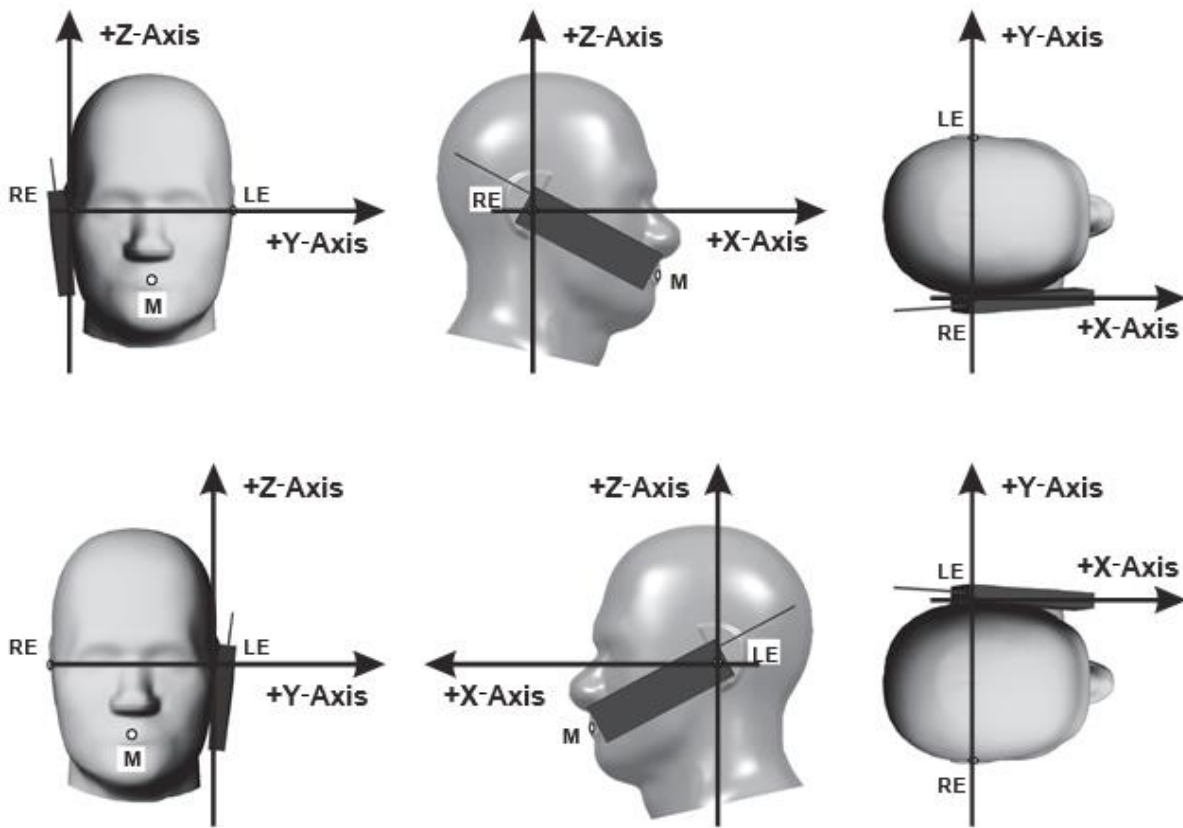

Figure 2.2.2-3 Definition of Coordinate System for SAM Head Phantom

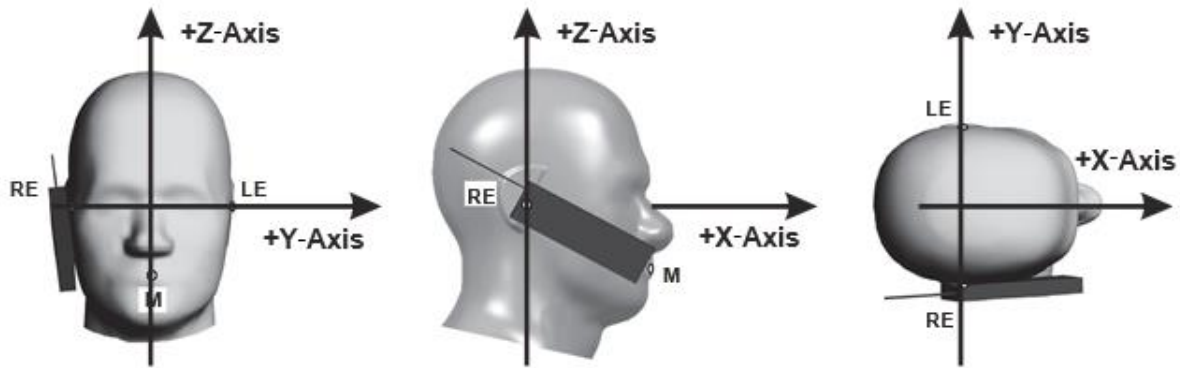

Figure 2.2.2-4 Alternate Coordinate System for SAM Head Phantom

### 2.2.3 Head and Hand Phantom (“Talk Mode”)

The head and hand phantom configuration is used to simulate the same “talk mode” of operation as the head-only configuration of Section 2.2.2, but is intended to be more realistically representative because it also includes the hand. Additionally, the head and hand “talk mode” configuration specifies that the DUT not be in direct physical contact with the cheek of the head phantom, but rather, tilted away from the cheek by an angle of  $6^\circ$ . This “six degrees from touch position” is based on user studies and is intended to more realistically represent real-world operation of the DUT.

Standard positioning of the DUT in the hand phantom varies with the choice of hand phantom being used. The choice of hand phantom for a given DUT is defined in Section 2.1.2.1.1 of *CTIA 01.01* [1]. The positioning of the DUT in each type of hand phantom is defined in the subsequent subsections, Section 2.2.4 through 2.2.6.

Positioning of the combined hand+DUT against the head is analogous to the positioning of the DUT for the head-only configuration of Section 2.2.2 with the exception that the  $6^\circ$  tilt angle from the cheek is used instead of direct contact with the cheek of the head phantom. The same coordinate system and reference points previously defined on the head phantom and DUT are used. The alternate coordinate system shown in Figure 2.2.2-4 may be used if the additional ripple test according to Section 5.4 of *CTIA 01.73* [2] has been performed and the results are included in the uncertainty calculation.

Finding the correct “ $6^\circ$  from touch” position against the head phantom may be difficult while the DUT is in the grasp of the hand phantom - in particular, the fingertips of the hand phantom may extend beyond the face of a thin DUT and act as an obstruction. An optional mask spacer is available for the head phantom, to assist with locating and maintaining the DUT in the desired “ $6^\circ$  from touch” position. The mask is a 32 mm wide conformal strip, created by sweeping the surface of the head phantom through a  $6^\circ$  rotation about the ear. Direct DUT contact against the mask thus establishes the required  $6^\circ$  spacing away from the head, regardless of DUT form factor. The material for the head phantom mask spacer shall be solid with a dielectric constant of less than 1.3 and a loss tangent of less than 0.003. Material additions around the nose, mouth, or opposite side of the head phantom may help to fix the mask spacer onto the head phantom.

In the situation where the fingertips of the hand phantom obstruct the DUT from touching the mask in the cheek region, then the hand+DUT will be rotated beyond  $6^\circ$  such that the fingertips just touch the head phantom.

(a) Right-sided positioning of the mask spacer

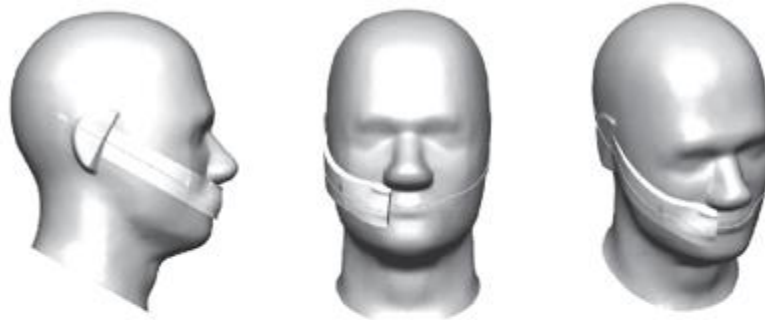

(b) Left-sided positioning of the mask spacer

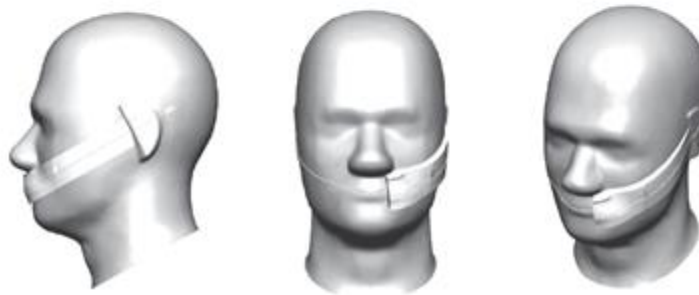

Figure 2.2.3-1 Optional Head Phantom Mask Spacer on SAM Head Phantom

The DUT shall be mounted in a suitable hand phantom and placed in a tilted position (cheek + 6 degrees) on the head phantom.

1. Ready the DUT for operation, if necessary.
2. Mount the DUT onto the palm spacer and place it in the hand phantom, as defined in the appropriate subsequent subsection (2.2.4 through 2.2.6) for the type of hand phantom being used. This subassembly of hand phantom, palm spacer and DUT is now referred to as the “hand+DUT.”
3. If the optional 6 degree head phantom mask spacer will be used, then affix it to the head phantom as shown in Figure 2.2.3-1 utilizing the appropriate right-sided or left-sided configuration.
4. Orient the hand+DUT so that the DUT is facing the head phantom with its vertical (longitudinal) centerline aligned in the reference plane (as indicated by an engraved line passing through the ears and mouth of the head phantom) and its acoustic output oriented toward the ear.
5. If necessary, rotate the hand+DUT around the vertical centerline of the DUT so that its contacting edge at the acoustic output is parallel to the flat plane of the ear on the head phantom. Note that the flat ear surfaces of the head phantom are not vertical but rather tapered slightly inward at the bottom.
6. While keeping the DUT vertical centerline aligned with the reference plane marking on the head phantom, translate the hand+DUT toward the head phantom until the DUT makes a flat, two-point contact with the ear. The horizontal line passing through the acoustic output



of the DUT (as defined in Section 2.1) should be aligned with the perpendicular NF line marking that crosses through the ear.

7. Rotate the hand+DUT about the ear axis (i.e., the perpendicular NF line) until any third point on the DUT makes physical contact. If the device is thin and the mask spacer is not being used, it may be necessary to bend away the flexible fingers of the hand phantom to allow contact between the head phantom and the DUT without obstruction. If the head phantom mask spacer is used, rotate the hand+DUT about the ear axis (i.e., the perpendicular NF line) until any third point of the hand+DUT makes physical contact with either the head phantom mask spacer or the surface of the head phantom itself.
8. If the mask spacer is not being used, then it is necessary to again rotate the hand+DUT about the ear axis (i.e., the perpendicular NF line) back away from the head phantom by 6 degrees from the three-point touch position. If the fingers of the hand phantom were bent to allow contact between the head phantom and the DUT without obstruction, then they shall be moved back to their proper positions. If it is not possible to reposition the fingers due to interference with the head phantom, then the DUT shall be rotated further away from the head until the fingers, when positioned correctly, just touch the head phantom.

The assembled head and hand configuration is shown in [Figure 2.2.3-2](#) for an example DUT tested with the monoblock hand phantom and palm spacer in both right-sided and left-sided configurations.

The tolerance on the tilt angle specified in step 7 or 8 must be within  $\pm 2^\circ$ . The tilt angle tolerance using the mask spacer shall be assessed by the ATL or the tilt angle shall be able to be measured using a scale that is an integral part of the fixturing or with a suitable gauge. The tilt angle  $r_2$  is defined in Section 2.13.2.5.2 of *CTIA 01.70* [3].

Section 2.13.2.6 of *CTIA 01.70* [3] gives an example of the uncertainty assessment for DUT positioning using a value for  $r_2$  (deg) of  $\pm 0.5^\circ$ . The actual angular uncertainty for  $r_2$  shall be used to calculate the DUT positioning measurement uncertainty.

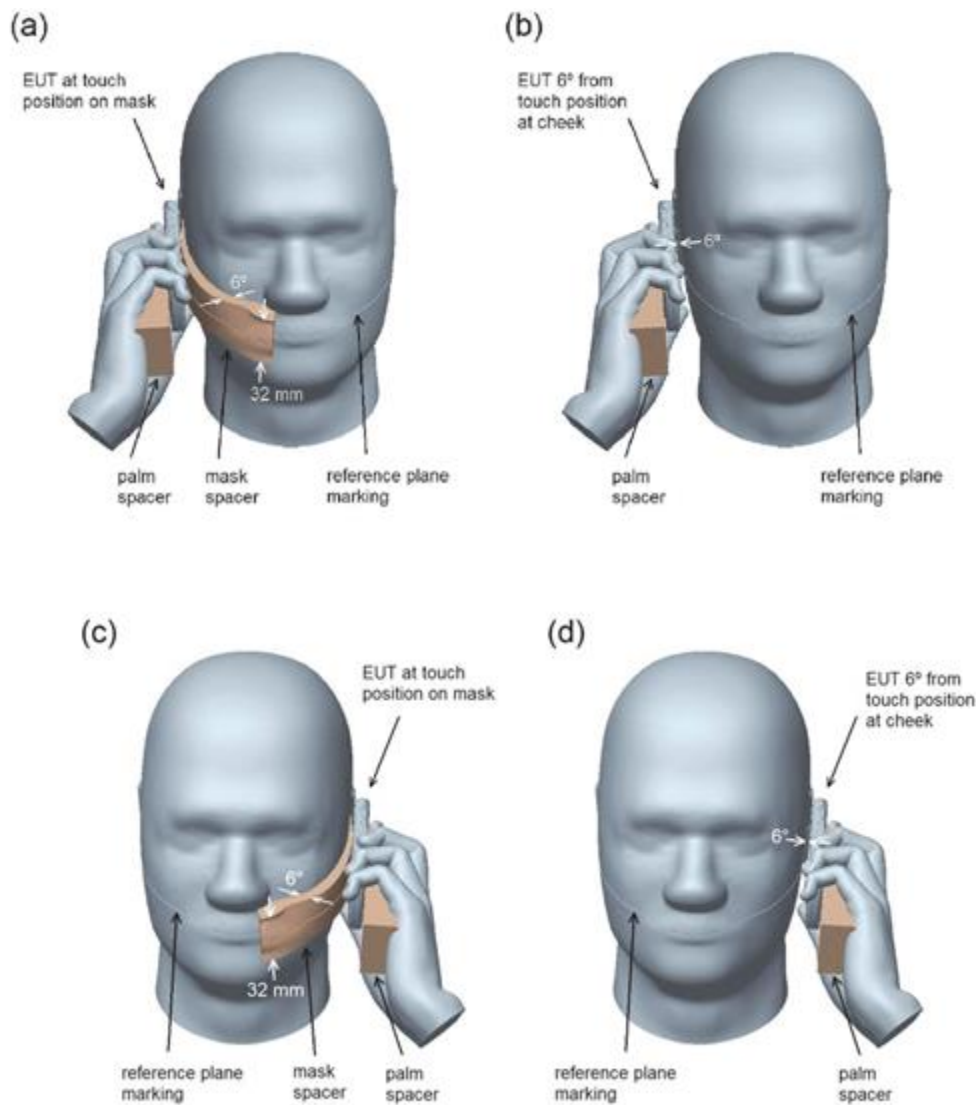

Figure 2.2.3-2 Head and Hand Configuration (A) With and (B) Without Mask Spacer (Right), (C) With and (D) Without Mask Spacer (Left)

## 2.2.4 Mounting Monoblock DUT in Monoblock Hand Phantom for Talk Mode

This procedure applies to mounting monoblock DUTs, closed portrait slide DUTs and closed rotator DUTs, when the DUT is less than 56 mm wide.

User grip studies indicate that the average grip for this type of DUT has the index finger pressing against the back, the ring finger in contact with the DUT at the bottom, and the pinky not touching the DUT. To help maintain a consistent, repeatable positioning that conforms to the grip studies, an alignment tool with evenly spaced rulings is first used to measure the DUT. The DUT is then positioned in accordance with ruled markings on a conformal palm spacer. Alignment Tool A (see [Figure 2.2.4-1](#)) features a 120° interior corner to help ensure that the ring fingertip lands in the desired position at the bottom of the DUT, regardless of any curvature in the DUT corners. There are two ruled scales: a bottom ruler (measuring down from the 120° corner) and a side ruler (measuring up from the 120° corner). The DUT is placed so

as to fit into the 120° corner and is measured from the bottom ruler. DUTs with rounded corners will sit lower in the tool than DUTs having square corners, and thus give a different reading.

1. Place the DUT face-up in Alignment Tool A with its side along the side ruler, and slide it down until it makes contact at the 120° corner as shown in Figure 2.2.4-1.
2. Measure and record the bottom of the DUT by reading off the bottom ruler of Tool A.
3. Observe the top of the DUT against the side ruler of the tool. If the top of the DUT extends past the 120 mm marking on the side ruler, then the additional length beyond 120 mm shall be added to the reading from step 2.
4. Position the DUT on the monoblock palm spacer (Figure 2.2.4-2). The vertical centerlines of the DUT and the palm spacer shall be superposed. The bottom of the DUT shall be lined up with the ruled marking on the palm spacer that corresponds to the reading from the alignment tool, as determined in steps 2 and 3. The DUT may optionally be affixed to the palm spacer with the help of touch fastener material.
5. Position the conformal palm spacer, with DUT, into the grasp of the monoblock hand phantom. Ensure that the index fingertip contacts the back of the DUT and the ring finger contacts the side of the DUT near its bottom.

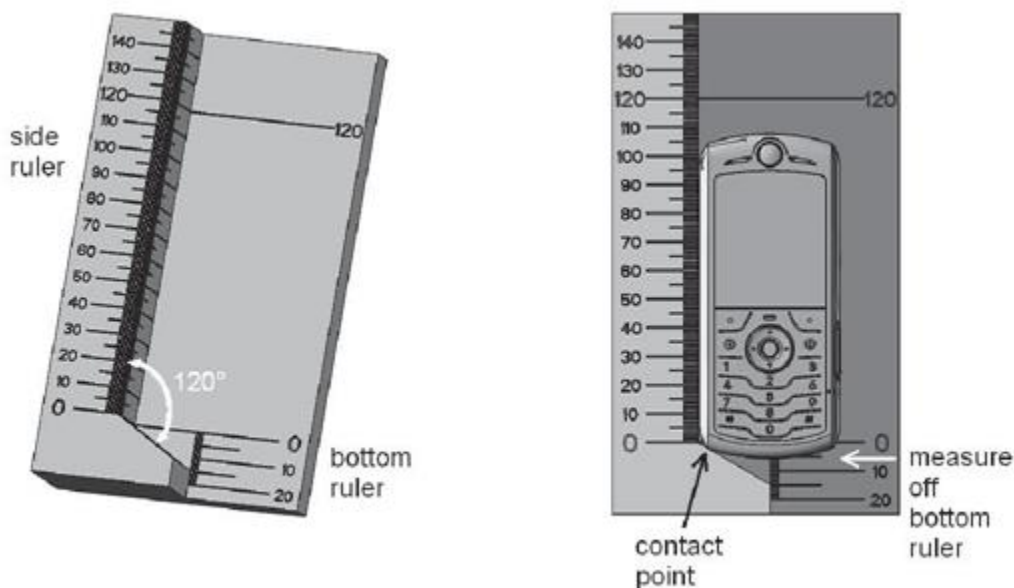
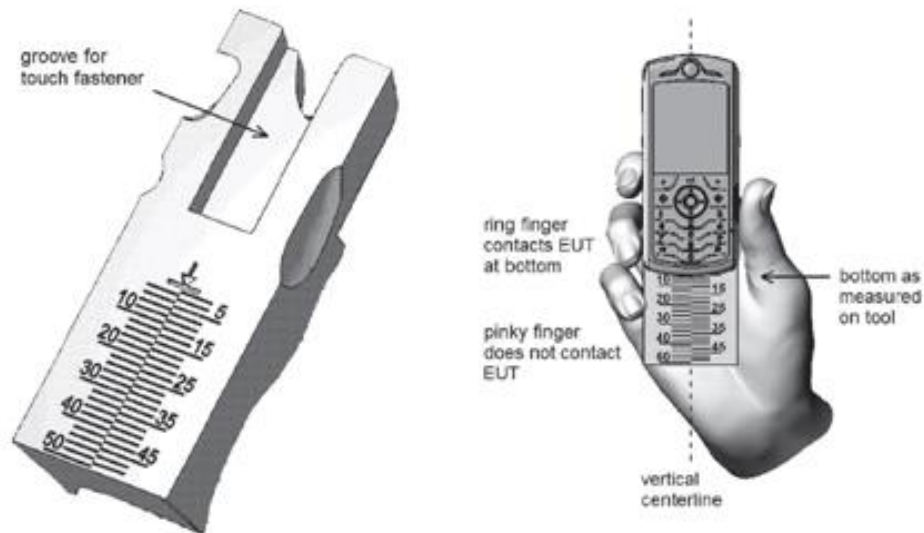

Figure 2.2.4-1 Alignment Tool A

The material for the monoblock palm spacer shall be hollow with a wall thickness less than 2 mm, and a dielectric constant of less than 5.0 and a loss tangent of less than 0.05 or it shall be solid with a dielectric constant of less than 1.3 and a loss tangent of less than 0.003. It may feature an optional groove or cavity to accommodate touch fastener material.



**Note:** A mirror-image configuration of the palm spacer shall be used for the left-handed monoblock grip.

Figure 2.2.4-2 Monoblock Palm Spacer

### 2.2.5 Mounting Fold DUT in Fold Hand Phantom for Talk Mode

This procedure applies to fold and open portrait slide/rotator DUTs when the DUT is less than 56 mm wide.

User grip studies indicate that the average grip for this type of DUT has the index finger pressing against the back of the flip above the hinge, and the thumb and remaining fingers gripping the base below the hinge. To help maintain a consistent, repeatable positioning that conforms to the grip studies, an alignment tool with evenly spaced rulings is first used to measure the DUT. The DUT is then positioned in accordance with ruled markings on a conformal palm spacer. Alignment Tool B (see [Figure 2.2.5-1](#)) features two rounded humps upon which the DUT is suspended. One hump represents the index fingertip of the hand phantom, while the other represents the palm spacer. This design helps ensure that the index finger remains in contact with the flip for any fold DUT geometry, regardless of hinge position or fold angle. The tool also features a line marking along its side wall, for aligning the DUT hinge axis of rotation for consistent positioning. The ruled scale for measuring the bottom of the DUT is split-level in order to minimize parallax discrepancies when measuring DUTs that are suspended above the ruler by their fold angle.

1. Open the DUT and rest it face-up on Alignment Tool B with its hinge suspended between the two humps, as shown in [Figure 2.2.5-1](#) and [Figure 2.2.5-2](#). The side of the DUT shall be aligned against the side wall of the tool. The base of the DUT shall rest on the wide hump with ruled markings, and the flip of the DUT shall rest on the narrow hump.
2. If a fold DUT, then slide the DUT longitudinally so as to align its hinge axis of rotation with the line marking engraved on the side wall of the tool, as closely as possible such that the DUT is not physically lifted off from either hump of the tool ([Figure 2.2.5-1](#)). If an open portrait slide or rotator DUT, then slide the DUT longitudinally until the base part of the DUT touches the narrow hump of the tool ([Figure 2.2.5-2](#)).
3. Measure and record the bottom of the DUT by reading off the bottom ruler of Tool B. Visually align the two halves of the split-level ruler to minimize parallax reading error.

4. Position the conformal fold palm spacer (Figure 2.2.5-3) in the fold hand phantom corresponding to the right-handed or left-handed configuration.
5. Position the DUT in the fold hand phantom, resting on the index fingertip and palm spacer, with the bottom of the DUT aligned to the ruling on the palm spacer that corresponds to the reading from step 3. Ensure that all fingertips are in contact with the DUT. Touch fastener material may be used to affix the DUT to the palm spacer.

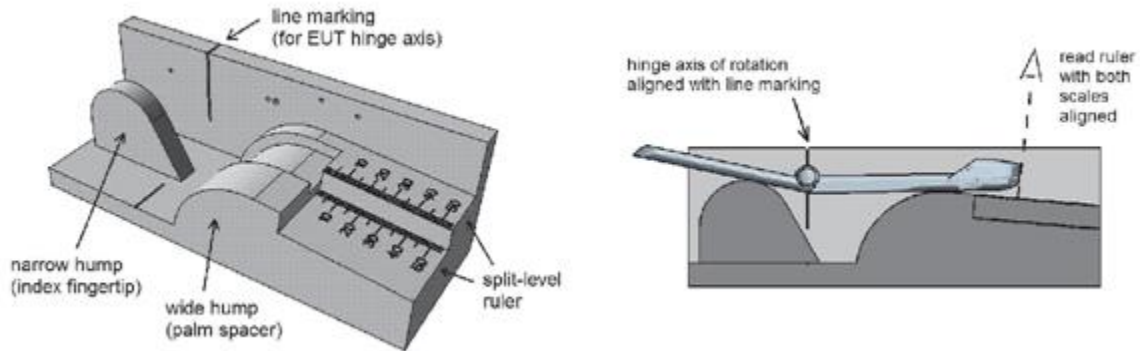

Figure 2.2.5-1 Alignment Tool B and Usage with Fold DUT

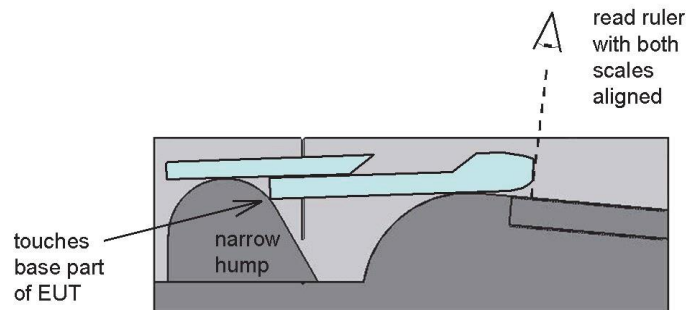
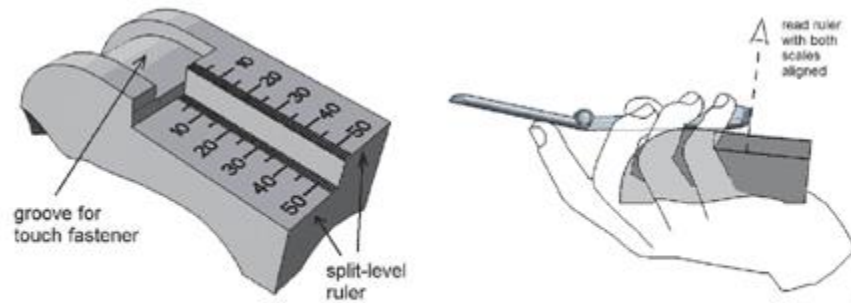

Figure 2.2.5-2 Usage of Alignment Tool B with Open Portrait Slide DUT

The material for the fold palm spacer shall be hollow with a wall thickness less than 2 mm, and a dielectric constant of less than 5.0 and a loss tangent of less than 0.05 or it shall be solid with a dielectric constant of less than 1.3 and a loss tangent of less than 0.003. It features a split-level ruler to avoid parallax errors, and a groove to accommodate touch fastener material.



**Note:** A mirror-image configuration of the palm spacer shall be used for the left-handed fold grip.

Figure 2.2.5-3 Fold Palm Spacer

## 2.2.6 Mounting Wide DUT in PDA Hand Phantom for Talk Mode

This procedure applies to DUTs 56 to 72 mm wide, for talk position.

User grip studies have shown that the average grip for this type of DUT has the index finger pressing against the back near the top and the thumb at the side. To help achieve a consistent positioning that conforms to the grip studies, the DUT is aligned to the PDA palm spacer (see [Figure 2.2.6-1](#)). No alignment tool is required. The PDA spacer features side and bottom walls to help ensure consistent alignment of DUTs of various sizes.

1. Place the DUT on the PDA spacer (see [Figure 2.2.6-1](#)).
2. Align the DUT to the side wall of the PDA (see [Figure 2.2.6-2](#)).
3. If the DUT is shorter than 135 mm, then align the top of the DUT with the top of the PDA spacer as shown in [Figure 2.2.6-2](#). Otherwise, align the bottom of the DUT with the bottom wall of the PDA spacer.

The material for the PDA palm spacer shall be hollow with a wall thickness less than 2 mm, and a dielectric constant of less than 5.0 and a loss tangent of less than 0.05 or it shall be solid with a dielectric constant of less than 1.3 and a loss tangent of less than 0.003. It may feature a groove or cavity to accommodate touch fastener material.

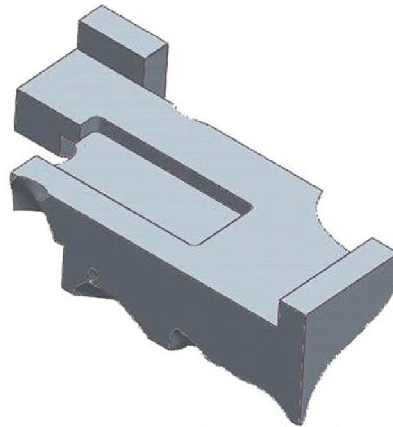

Figure 2.2.6-1 PDA Palm Spacer

**Note:** A mirror-image configuration of the palm spacer shall be used for the left-handed grip.



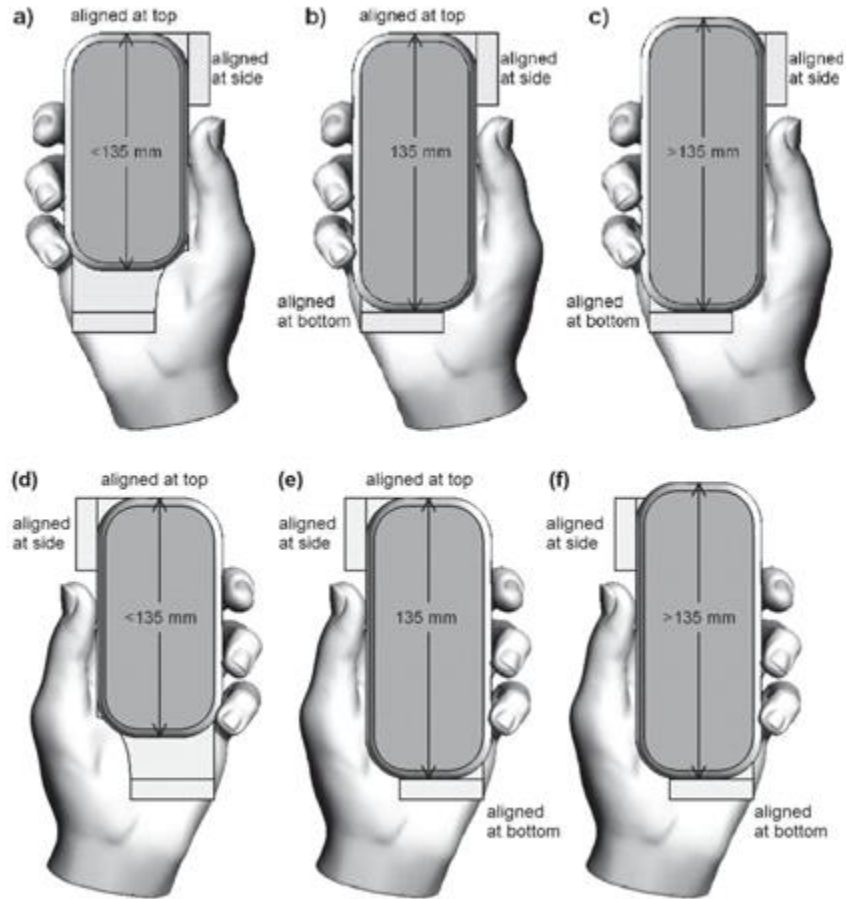

Figure 2.2.6-2 Positioning of Wide DUT with Respect to PDA Palm Spacer

### 2.2.7 Mounting a Wide DUT in the Wide Grip Hand Phantom for Talk Mode

This procedure applies to DUTs exceeding 72 mm but not 92 mm in width.

The Wide Grip hand phantom features an angular palm cutout at the base of its thumb, featuring two flat wall surfaces for contacting the DUT at its corner. The conformal palm spacer for the Wide Grip includes an additional wall support at its side, near the thumb. The corner of the DUT shall be fitted into the phantom palm cutout so that physical contact is maintained with each of its two flat walls, with the palm spacer wall support near the thumb, and with the deflected thumb itself, as shown in [Figure 2.2.7-1](#).



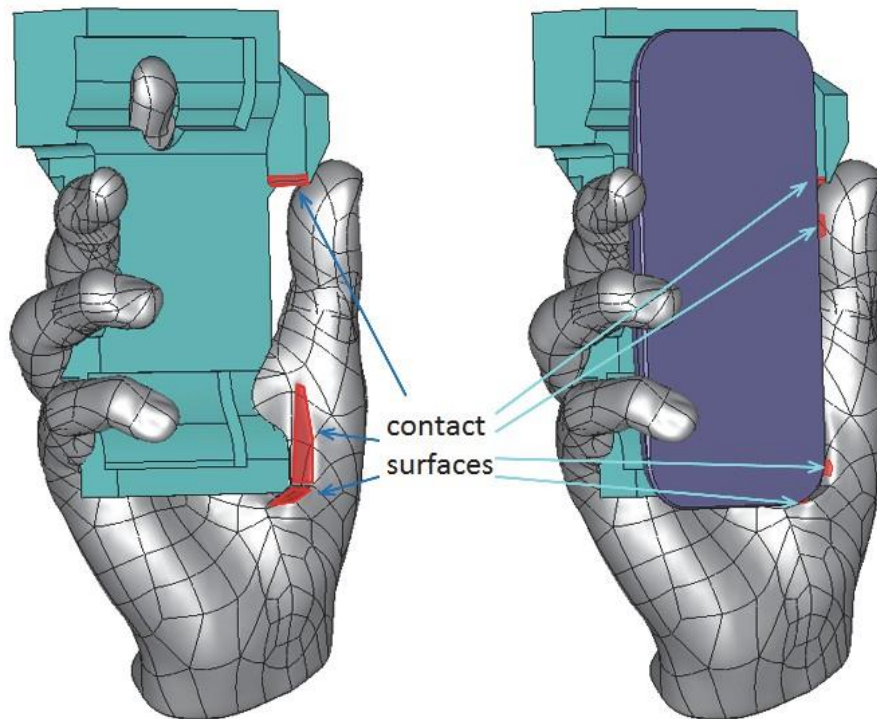

Figure 2.2.7-1 Wide Grip Hand Phantom Contact Points

Additionally, the DUT shall be affixed or otherwise contacted to rounded surfaces of the conformal palm spacer (Figure 2.2.7-2), e.g., with heavy duty touch fastener.

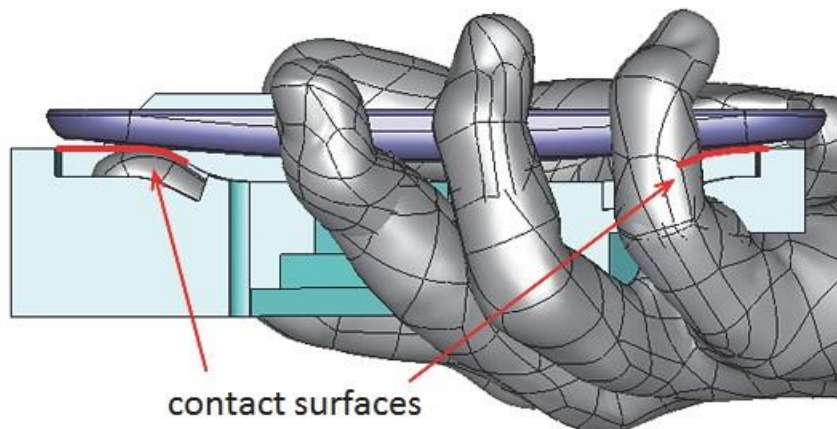

Figure 2.2.7-2 Wide Grip Palm Spacer Contact Surfaces

If the DUT features a protruding side key in a location around its perimeter that could cause unintended actuation during OTA measurements by the structure of the hand phantom or the palm spacer, then a grommet can be added to prevent actuation (Figure 2.2.7-3). Grommets shall be made of insulating material, and have the minimum thickness and dimensions required to prevent actuation of the side key.

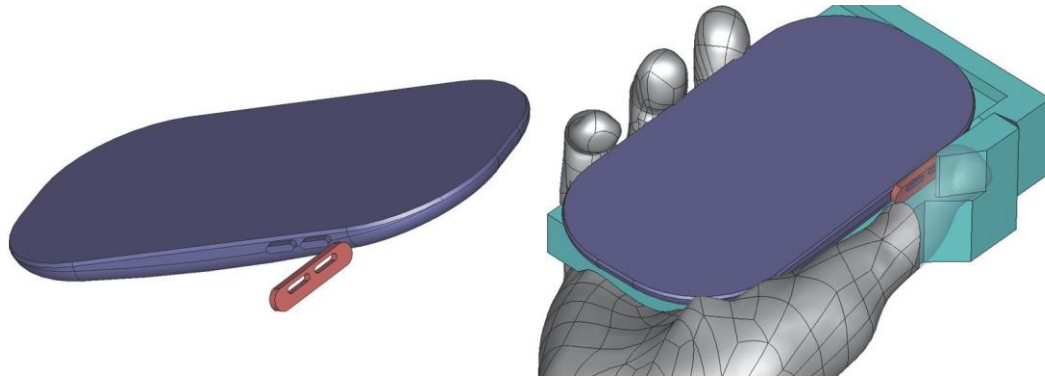

Figure 2.2.7-3 Insulating Grommet to Prevent Side Key Actuation

A combination of rounded DUT corner geometry, side keys and/or grommets may cause the longitudinal axis of the positioned DUT to be misaligned from the longitudinal axis of the palm spacer (and other fixturing elements) by an angle  $r_1'$  (Figure 2.2.7-4). This may cause the DUT to be misaligned from the MB reference plane of the head phantom (Figure 2.2.2-1) by the same angle, for “talk” mode (head-and-hand) measurements. In such cases, the palm spacer shall remain longitudinally aligned to the MB reference plane, and the earpiece of the DUT shall remain positioned with reference to the left and right ear reference points as described in section 2.2.3. The systematic angle between the DUT and palm spacer longitudinal axes  $r_1'$  need not be included in the angle  $r_1$  for calculating measurement uncertainty as described in Section 2.13.2.5 of CTIA 01.70 [3]. Rather, angle  $r_1$  from the MB reference plane of the head phantom shall be evaluated with respect to the longitudinal axis of the Wide Grip palm spacer.

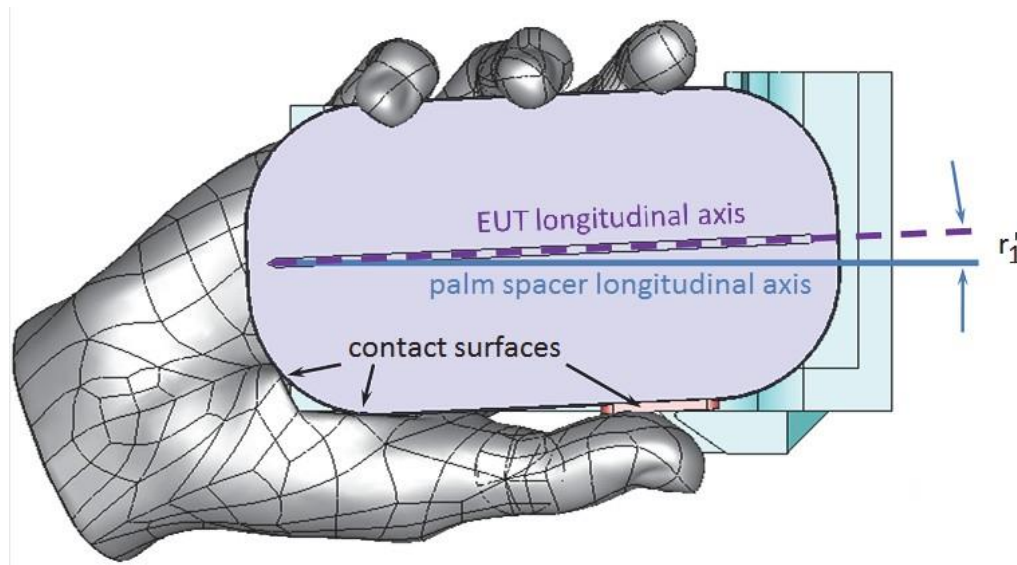

Figure 2.2.7-4 Wide Grip DUT Positioning Example With Rounded Corner, Side Key Grommet

## 2.2.8 Hand Phantom Only

The hand phantom only configuration is used to simulate data mode (browsing, navigation).

The DUT shall be mounted in a suitable hand phantom and oriented such that the DUT's main display is tilted 45 degrees  $\pm$  5 degrees from vertical.

1. Ready the DUT for operation, if necessary. For example, for devices with a cover piece, open the cover.
2. Mount the DUT in the hand (refer to the following subsections)
3. Define a line L that is normal to the plane of the main display and passes through its center. Define a line M that lies within the plane of the main display, intersecting L, and lies parallel to the horizontal axis of the display. See [Figure 2.2.8-1](#).
4. Define a Cartesian coordinate system with its origin at the L-M intersection, where the positive Y-axis lies along M pointing to the right of the phone. Define the positive X-axis to face away from the display at an angle 45 degrees "below" line L and the positive Z-axis to face away from the display 45 degrees "above" line L, as illustrated in [Figure 2.2.8-2](#). If necessary, the origin of the coordinate system may be translated from the center of the display to aid in orientation of the hand phantom and DUT combination provided that the DUT remains inside the quiet zone.

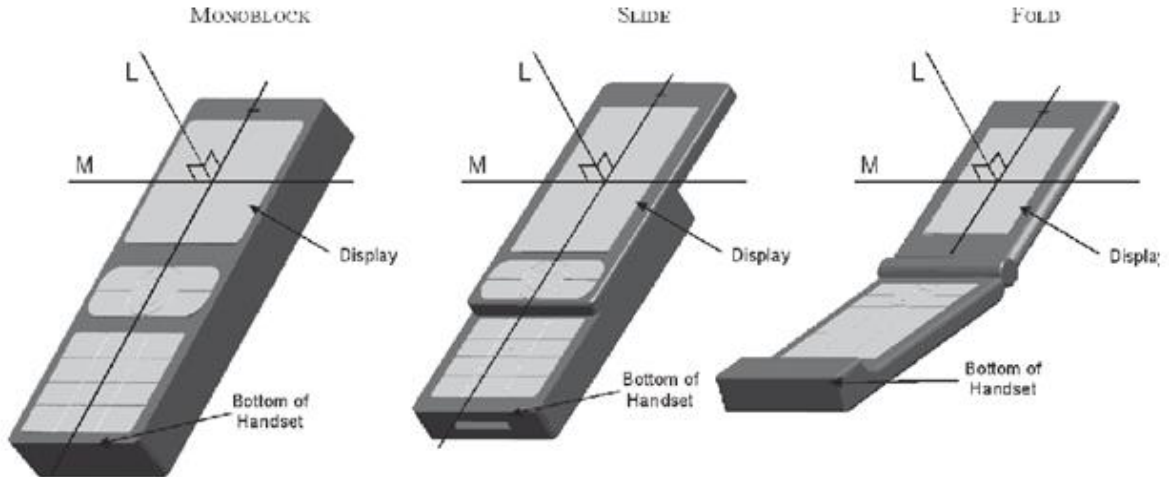

Figure 2.2.8-1 DUT Display Alignment Features

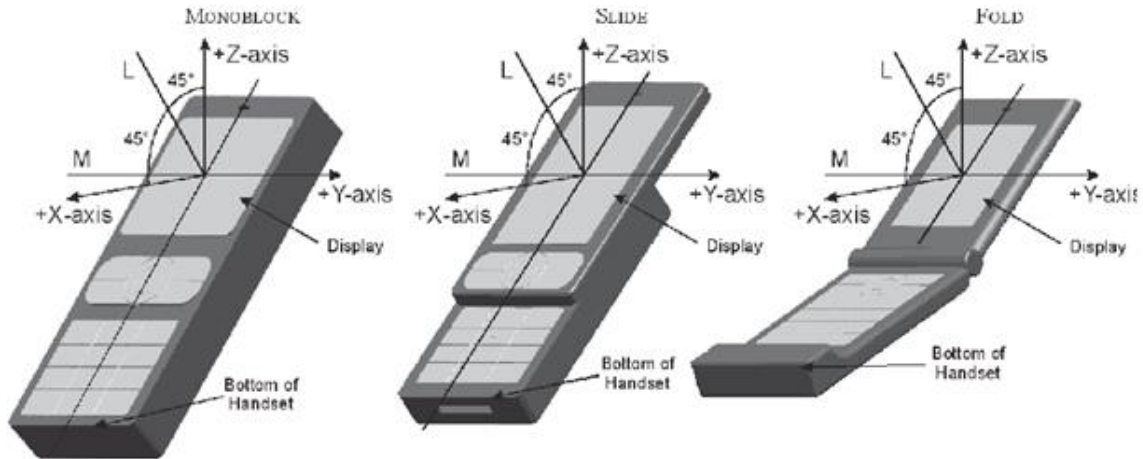

Figure 2.2.8-2 Definition of Coordinate System for DUT with Hand Phantom in Data Mode

## 2.2.9 Mounting a Narrow DUT in the Narrow Hand Phantom for Data Mode

This hand phantom is suitable for use with all DUTs narrower than 56 mm.

User grip studies have shown that the average grip for narrow DUTs has the index finger supporting the back of the device and the thumb positioned over a central navigation wheel or “nav key.” To help achieve a consistent positioning that conforms to the grip studies, Alignment Tool A (Figure 2.2.9-1) is first used to measure the distance between the bottom of the DUT and the center of its nav key. The DUT is then positioned in accordance with ruled markings on a conformal palm spacer corresponding to the right or left configuration.

1. Place the DUT on the DUT alignment tool A (as shown in Figure 2.2.9-1).
2. Record the chin length from the scale at the bottom of the alignment tool.
3. Record the location of the navigation key (or the “2” key, if no navigation key is present) on the side ruler of the DUT alignment tool A. The key's center is used as the reference.
4. Add the two readings from step 2 and 3 together. If the sum is less than 30 mm, then use 30 mm instead.
5. Place the DUT on the narrow data palm spacer and align the side of the DUT with the side wall of the spacer.
6. The bottom edge of the DUT shall be placed on the narrow data palm spacer at the ruling corresponding to the value obtained in step 4 (See Figure 2.2.9-2).
7. Ensure that the index finger is in contact with the back of the DUT. If the device is very narrow and/or thin, it may occur that the middle finger does not curl tightly enough to contact the DUT. In such case, in order to ensure consistent test results, no attempt should be made to force the fingertip to contact the DUT. Touch fastener material may be used to maintain the DUT in the desired position.

The material for the narrow data palm spacer shall be hollow with a wall thickness less than 2 mm, and a dielectric constant of less than 5.0 and a loss tangent of less than 0.05 or it shall be solid with a dielectric constant of less than 1.3 and a loss tangent of less than 0.003. It may feature a groove or cavity to accommodate touch fastener material.

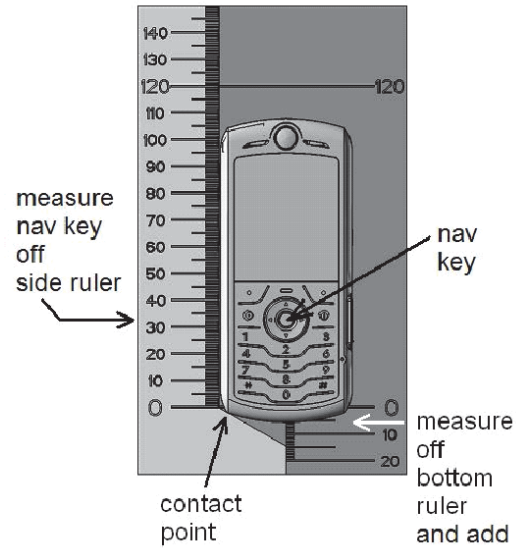
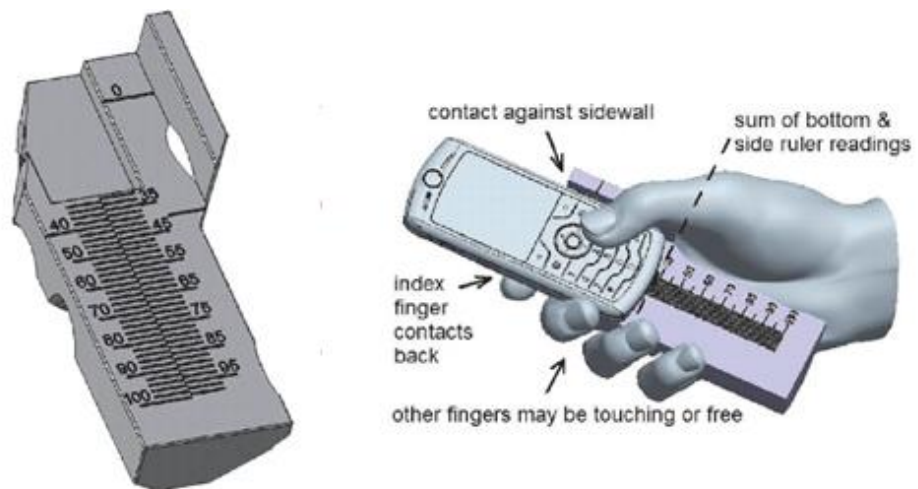

Figure 2.2.9-1 Measuring a Narrow DUT in Alignment Tool A for Hand Only ("Data Mode") Testing



**Note:** A mirror-image configuration of the palm spacer shall be used for the left-handed narrow data grip.

Figure 2.2.9-2 Narrow Data Palm Spacer

### 2.2.10 Mounting a Wide DUT in the PDA Phantom for Data Mode

This hand phantom is suitable for use with DUTs of width 56-72 mm. The positioning of the DUT in the PDA hand for data mode is identical to that for talk mode, and is already described in Section 2.2.6.



### 2.2.11 Mounting a Wide DUT in the Wide Grip Phantom for Data Mode

The Wide Grip hand phantom is for a DUT having width greater than 72 mm, and not greater than 92 mm. Positioning of the DUT in the Wide Grip hand phantom for data mode is identical to that for talk mode, as described in Section [2.2.7](#).

## 2.3 Positioning and Setup Requirements for Wrist-Worn Devices

The DUT shall be tested in a normal operating state, but shall be configured as follows (as applicable).

The manufacturer shall provide instructions to the ATL for placing the DUT in this state.

- Transmitting radios:
  - WWAN - On
  - WLAN (Wireless Local Area Network) - Off
  - Bluetooth™ - Off
  - WiMAX™ - Off
  - UWB (Ultra Wideband) - Off
  - All other embedded transmitting radios that are not being tested - Off
- Power Settings
  - Device should be placed into normal operating mode (minus the radio configuration as explained above)
  - Power by battery, if possible, to reduce interference (standard manufacturer's battery)

The manufacturer shall declare the wristband to be used during the testing. The wristband to be used shall be the wristband packaged with the end product. If wristbands are provided separately, the wristband selection shall be based on the expected worst-case wristband.

The manufacturer shall declare the housing material to be used during the test based on the expected worst-case material.

### 2.3.1 Positioning of Wrist-Worn DUT Relative to the Chamber Coordinate System

The forearm phantom shall be mounted in the chamber coordinate system as shown in [Figure 2.3.1-1](#).

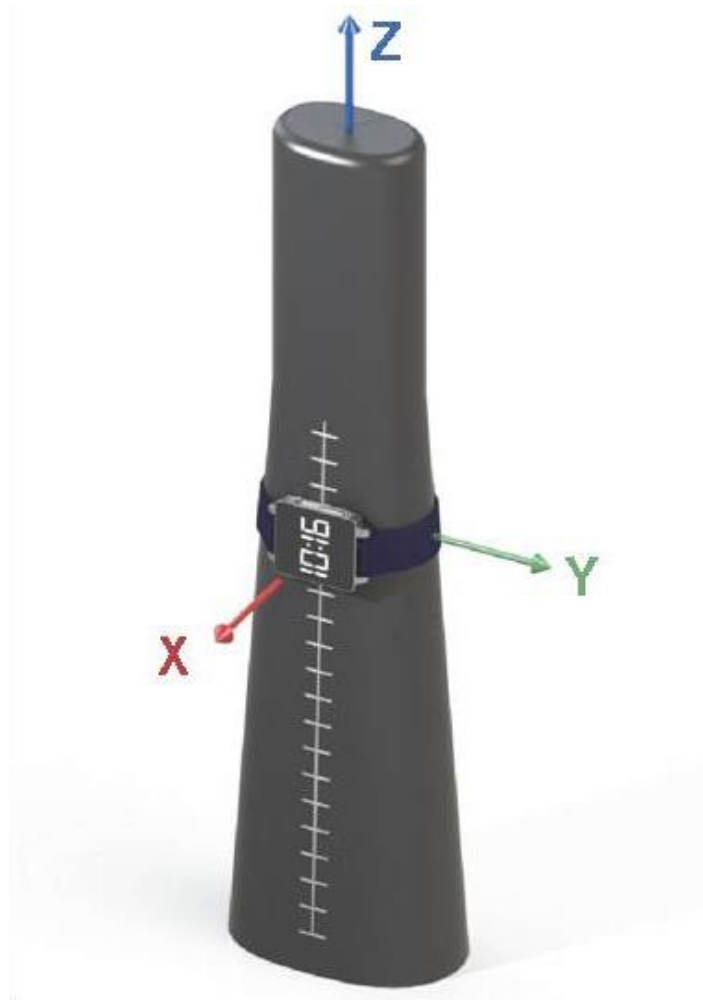

Figure 2.3.1-1 Cartesian Coordinate System for Forearm Phantom

### 2.3.2 Mounting a Wrist-Worn DUT on the Forearm Phantom

Define Plane *J* and Plane *K* as shown in [Figure 2.3.2-1](#). Plane *J* cuts through the surface of the forearm phantom and passes through the target test position and is perpendicular to the Y-axis. Plane *J* is the X-Z plane. Plane *K* cuts through the forearm phantom at the target test position and is perpendicular to the Z-axis. Plane *K* is the X-Y plane.



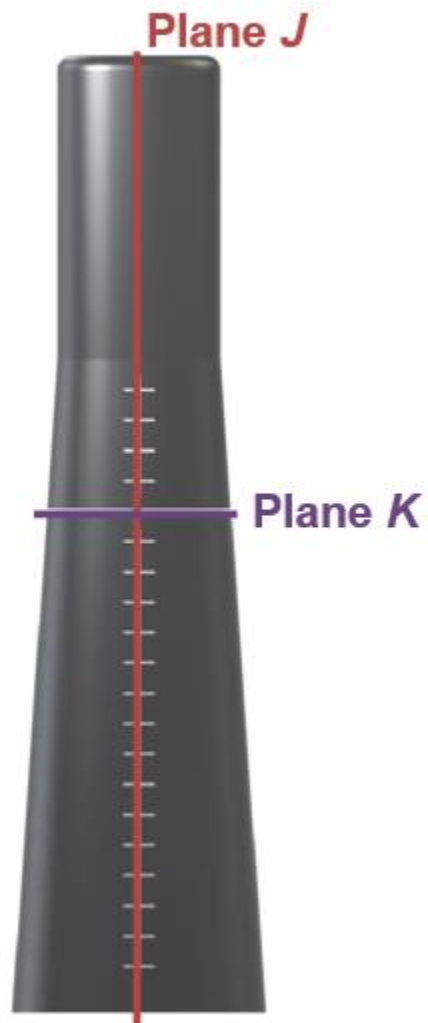

Figure 2.3.2-1 Definition of Plane *J* and Plane *K* on the Forearm Phantom

Define a local coordinate system for a wrist-worn device as shown in [Figure 2.3.2-2](#).

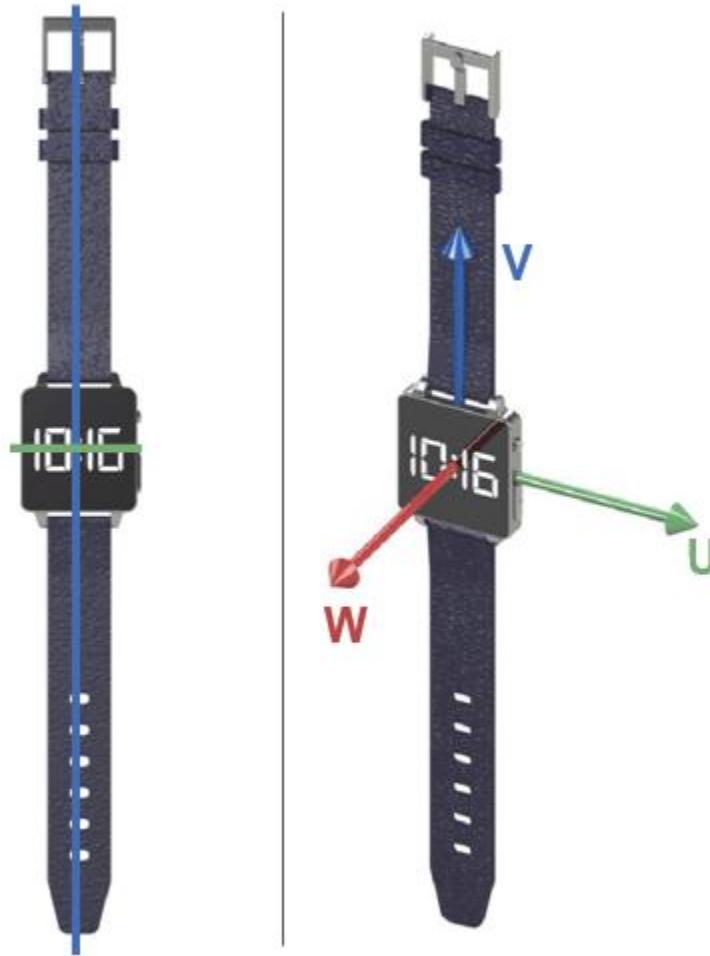

Figure 2.3.2-2 Local Coordinate System for a Wrist-Worn Device

First define a virtual Plane A that cuts through the center of wrist band on the U-axis and is perpendicular to the U-axis as shown in [Figure 2.3.2-3](#). Thin, narrow, non-conductive tape may be used to mark where Plane A cuts through the device without introducing any additional measurement uncertainty. If the lines are not marked, it is recommended to measure the width of the device with a ruler and mathematically determine the space needed between the side edges of the device and the nearest engraved graduated markings on the forearm.



Figure 2.3.2-3 Definition of Plane A and Plane B on a Wrist-Worn Device

In general, if the device has a wrist band which can be easily flattened, then define a virtual Plane *B* that cuts through the center of the display on the V-axis and is perpendicular to the V-axis, as shown in [Figure 2.3.2-3](#). Thin, narrow, non-conductive tape may be used to mark where Plane *B* cuts through the device without introducing any additional measurement uncertainty. Plane *B* shall be fully aligned with Plane *J* when the device is mounted on the forearm phantom as shown in [Figure 2.3.2-4](#).

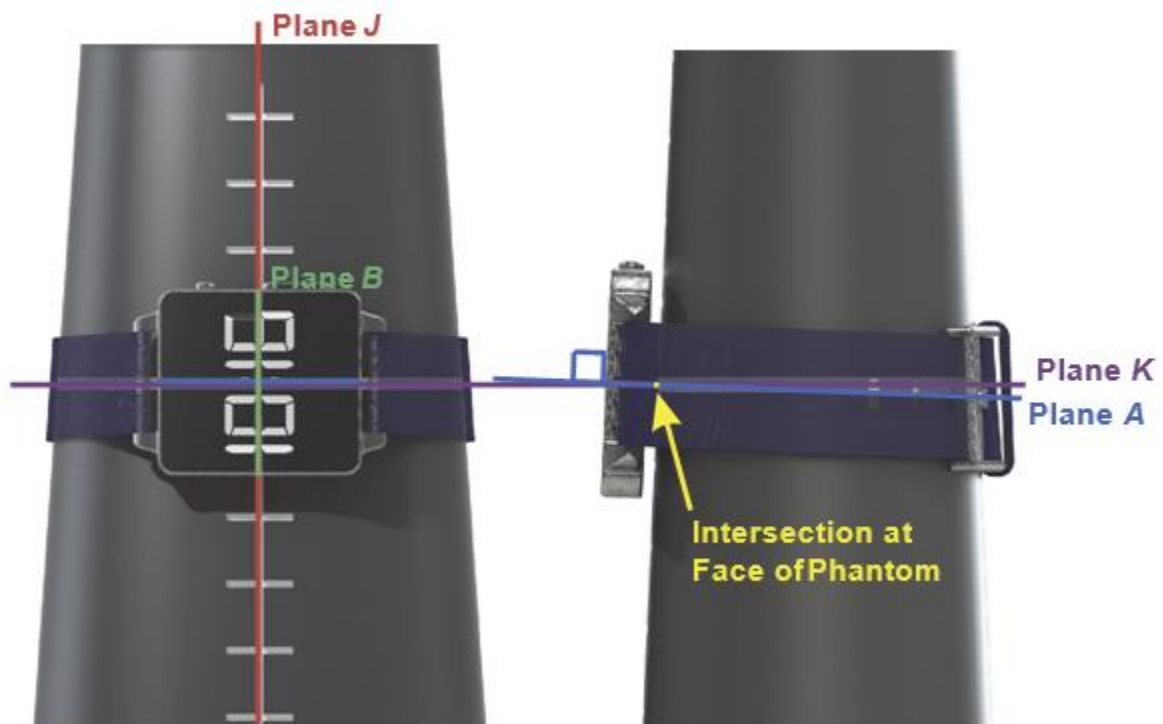

Figure 2.3.2-4 Alignment of Plane A with Plane K and Plane B with Plane J when a Wrist-Worn Device, which can be Laid Out Flat, Is Mounted on the Forearm Phantom

In [Figure 2.3.2-4](#), Plane A and Plane K shall intersect to form a line that is tangent to the surface of the forearm phantom at the target test position. Note that Plane A may only intersect Plane K to form a line that is tangent to the surface of the forearm phantom at the target test position, instead of being fully aligned, as seen in [Figure 2.3.2-4](#) because the band may need to be adjusted up or down in the Z direction in order to position the main module parallel to the forearm phantom surface.

If the device has a wrist band with a pre-formed shape, then define a virtual Plane B which is perpendicular to the V-axis and is located on the device such that Plane B shall fully align with the Plane J on the forearm phantom when the device is snugly fitted to the forearm phantom as shown in [Figure 2.3.2-5](#).

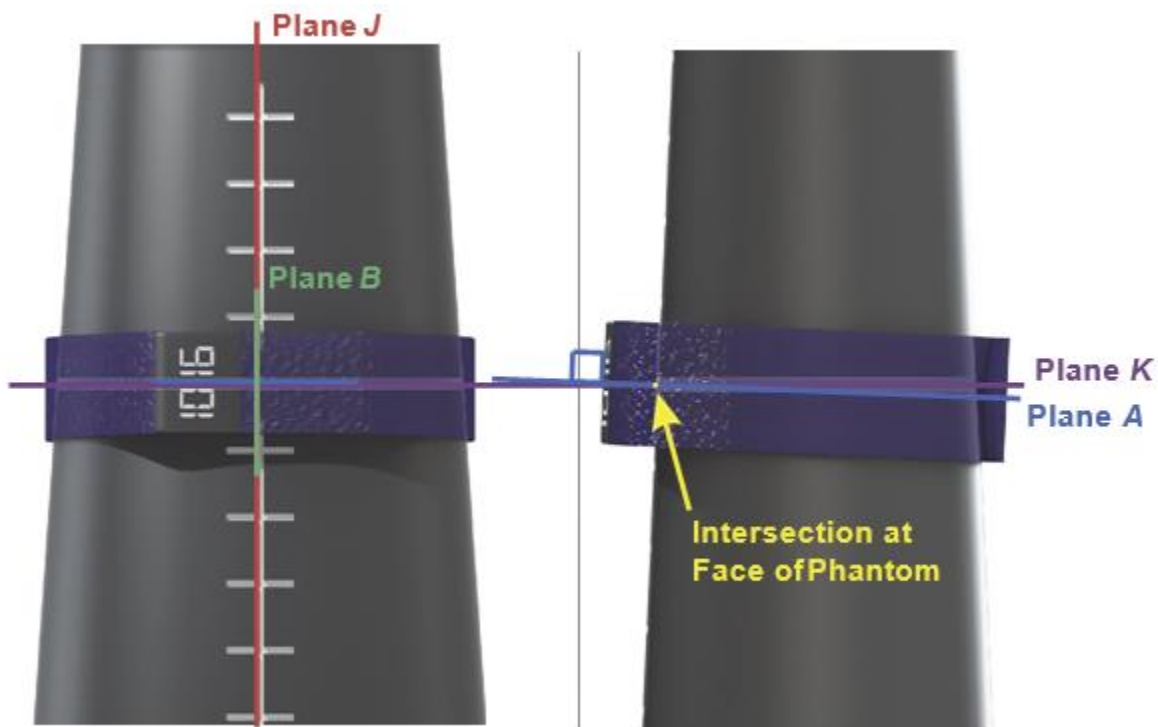

Figure 2.3.2-5 Alignment of Plane A with Plane K and Plane B with Plane J when a Wrist-Worn Device with a Pre-Formed Wrist Band Is Mounted on the Forearm Phantom

In both [Figure 2.3.2-4](#) and [Figure 2.3.2-5](#), the device shall be positioned such that Plane A is perpendicular to Plane J of the forearm phantom.

If the section of the pre-formed shape of the wrist band is somewhat symmetric, then Plane B shall be the centerline of the wrist band shape as shown in [Figure 2.3.2-6](#).

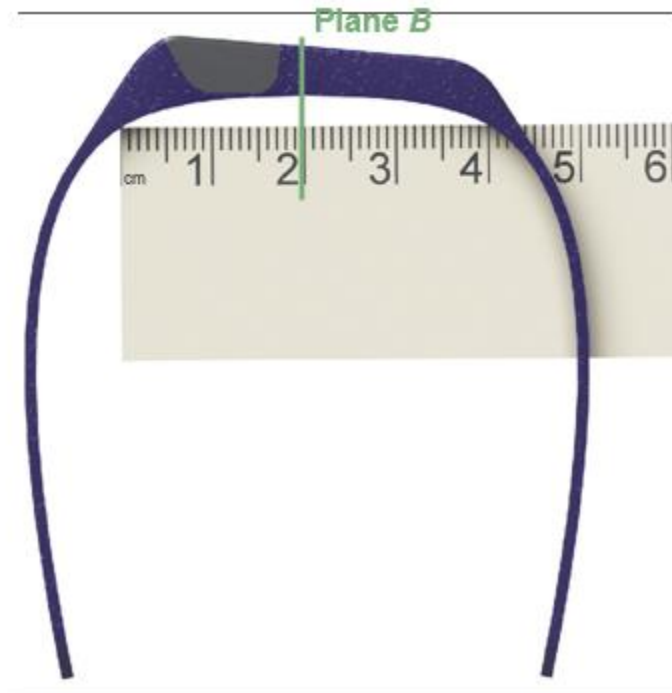

Figure 2.3.2-6 Location of Plane B on a Wrist-Worn Device with a Symmetric Pre-Formed Shape

In general bands with multiple buckle stops have sufficient flexibility to mount the device snugly at the target test position. It may be useful to follow these steps when mounting a wrist-worn device with a flexible band onto the forearm phantom: (a) place the device at the target location with the band open, (b) buckle the wrist band as tightly as possible, (c) slide the device off the forearm phantom with the buckle closed, (d) tighten the buckle by one stop, (e) slide the device back onto the forearm and into the target position.

For wrist-worn devices which are unable to snugly mount at the target test position, the DUT shall be tested with the band set so that the DUT is located as near as possible to the target test location, and snugly mounted. Test reports shall include a photograph of wrist-worn devices, which need to be mounted away from the target test position, mounted on the forearm phantom clearly showing the engraved markings on either side of the engraved target test position ring.

In all cases, DUTs shall be mounted with sufficiently snug band tightness so as to prevent the DUT from slipping off under the force of gravity when the phantom is inverted.

When there is flexibility in the positioning, the main module shall be kept parallel to the surface of the forearm phantom as shown in [Figure 2.3.2-7](#).



Figure 2.3.2-7 Examples of Correctly Mounting the Device on the Forearm Phantom by Keeping the Main Module Parallel to the Surface of the Forearm Phantom

In [Figure 2.3.2-8](#) the main module is tilted such that it is raised on the forearm phantom on the side closest to the hand.



Figure 2.3.2-8 Example of Incorrectly Mounting the Device on the Forearm Phantom by not Keeping the Main Module Parallel to the Surface of the Forearm Phantom

When the longitudinal test position for a given DUT is identified, the DUT will be tested at this longitudinal position for one of two different orientations, representing being worn on the right or left wrist (with the band and display oriented in opposite directions), as shown in [Figure 2.3.2-9](#).



Figure 2.3.2-9 Two Orientations of DUT On Forearm Phantom Representing the Left and Right Wrist



## 2.4 Positioning and Setup Guidelines for Chest-Worn Devices

The DUT shall be tested in a normal operating state, but shall be configured as follows (as applicable).

The manufacturer shall provide instructions to the ATL for placing the DUT in this state.

- Transmitting radios:
  - WWAN - On
  - WLAN (Wireless Local Area Network) - Off
  - Bluetooth™ - Off
  - WiMAX™ - Off
  - UWB (Ultra Wideband) - Off
  - All other embedded transmitting radios that are not being tested - Off
- Power Settings
  - Device should be placed into normal operating mode (minus the radio configuration as explained above)
  - Power by battery, if possible, to reduce interference (standard manufacturer's battery)

### 2.4.1 Positioning of Chest-Worn DUT Relative to the Chamber Coordinate System

The chest phantom shall be mounted in the chamber coordinate system as shown in [Figure 2.4.1-1](#).

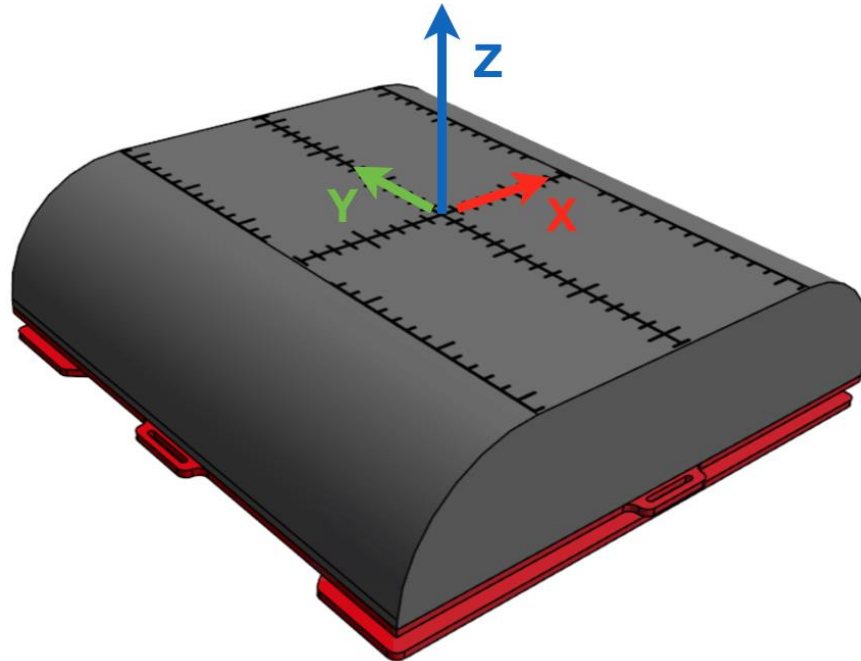

Figure 2.4.1-1 Cartesian Coordinate System for Chest Phantom

## 2.4.2 Mounting a Chest-Worn DUT on the Chest Phantom

Differing test configurations apply based on whether a manufacturer-approved carry accessory is required for proper DUT use.

A manufacturer approved carry accessory is an accessory that the manufacturer designs and provides for the use with a chest-worn device.

### 2.4.2.1 DUTs Provided without a Manufacturer-Approved Carry Accessory

The chest-worn device is tested in one position on the chest phantom, which shall be centered on, or on the side of the chest phantom. Due to the simplified nature of the chest phantom, the left and right sides are essentially the same. The manufacturer shall declare the orientation of the device when worn on the chest. The manufacturer declared orientation of the device when worn on the chest shall include the following:

1. The rotation of the DUT around the Z axis, including a photograph with clear markings
2. The center of the DUT in the x and y directions, including a photograph with clear markings
3. A description of how to place the device on the phantom so that the device does not teeter

A chest spacer representing thin clothing shall be used to separate the DUT from the surface of the chest phantom by 1mm. The chest spacer shall be 1mm thick, larger than in the x and y dimensions than the DUT but smaller than the flat surface of the chest phantom (325 x 185mm). The material for the chest spacer shall be solid with a dielectric constant of less than 1.3 and a loss tangent of less than 0.003. The chest spacer may include ruled markings similar to the ruled markings on the chest phantom to aid in positioning the DUT on the spacer and chest phantom.

The DUT shall be centered on the chest phantom. The center of the DUT shall be at the intersection of the X and Y axis in [Figure 2.4.1-1](#).

Both the chest spacer and DUT may be fixed to the chest phantom using thin plastic “packing” tape. No additional uncertainty assessment is needed if thin plastic “packing” tape is used to hold the chest spacer or DUT.

#### 2.4.2.2 DUTs Provided with a Manufacturer-Approved Carry Accessory

When the chest-worn DUT’s manufacturer recommended use case is to always be worn in a manufacturer-approved carry accessory (e.g., the holster of a professional portable radio), the DUT shall be placed in this carry accessory prior to installing in contact with the chest spacer defined in section 2.4.2.1 onto the chest phantom. If the DUT can be provided with more than one carry accessory, the carry accessory providing the closest distance between DUT and the chest phantom shall be employed, unless a different carry accessory is shown by the manufacturer to better represent the predominant usage share.

As an alternative to testing the DUT while placed in the carry accessory, the manufacturer may employ an overlying spacer, with its thickness defined by the separation distance provided by installing the DUT into the manufacturer-approved carry accessory. The material for the overlying spacer shall be solid with a dielectric constant of less than 1.3 and a loss tangent of less than 0.003. To aid positioning repeatability, the overlying spacer may be shaped with the specific DUT imprint. If the DUT can be provided with more than one carry accessory, it will be shaped in order to represent the distance from the chest phantom corresponding to the selected carry accessory.

The underlying (1-mm thick chest) spacer and the DUT (mounted on the carry accessory or the overlying spacer defined in the previous paragraph) may be fixed to the chest phantom using thin plastic “packing” tape. No additional uncertainty assessment is needed if thin plastic “packing” tape is used to hold the chest spacer or DUT.

The portion of the DUT incorporating all internal or external antennas engaged in the operating mode under test shall be centered on the chest phantom at the intersection of the X and Y axis in [Figure 2.4.1-1](#). When an external antenna is not engaged in the operating mode under test, it will not be considered in determining the portion of the DUT to be centered.

## 2.5 Positioning and Setup Guidelines for Ankle-Worn Devices

The DUT shall be tested in a normal operating state, but shall be configured as follows (as applicable).

The manufacturer shall provide instructions to the ATL for placing the DUT in this state.

- Transmitting radios:
  - WWAN - On
  - WLAN (Wireless Local Area Network) - Off
  - Bluetooth™ - Off
  - WiMAX™ - Off
  - UWB (Ultra Wideband) - Off
  - All other embedded transmitting radios that are not being tested - Off
- Power Settings

- Device should be placed into normal operating mode (minus the radio configuration as explained above)
- Power by battery, if possible, to reduce interference (standard manufacturer's battery)

### 2.5.1 Positioning of Ankle-Worn DUT Relative to the Chamber Coordinate System

The ankle phantom shall be mounted in the chamber coordinate system as shown in [Figure 2.5.1-1](#).

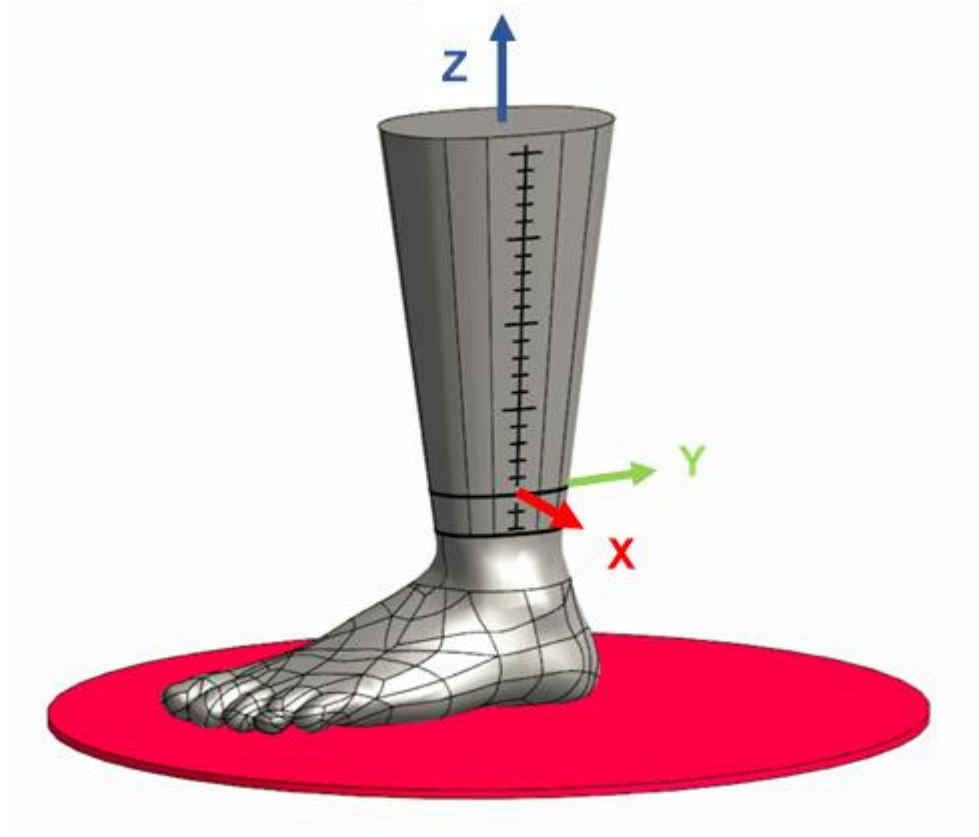

Figure 2.5.1-1 Cartesian Coordinate System for Ankle Phantom

### 2.5.2 Mounting an Ankle-Worn DUT on the Ankle Phantom

Define plane J and Plane K as shown in [Figure 2.5.2-1](#). Plane J is the X-Z plane and cuts through the surface of the ankle phantom and passes through the target test position and is perpendicular to the Y-axis. The target test position is only on the left side of the (left) ankle phantom, as ankle-worn devices are typically worn on that side. Plane K is the X-Y plane and cuts through the ankle phantom at the target test position and is perpendicular to the Z-axis.

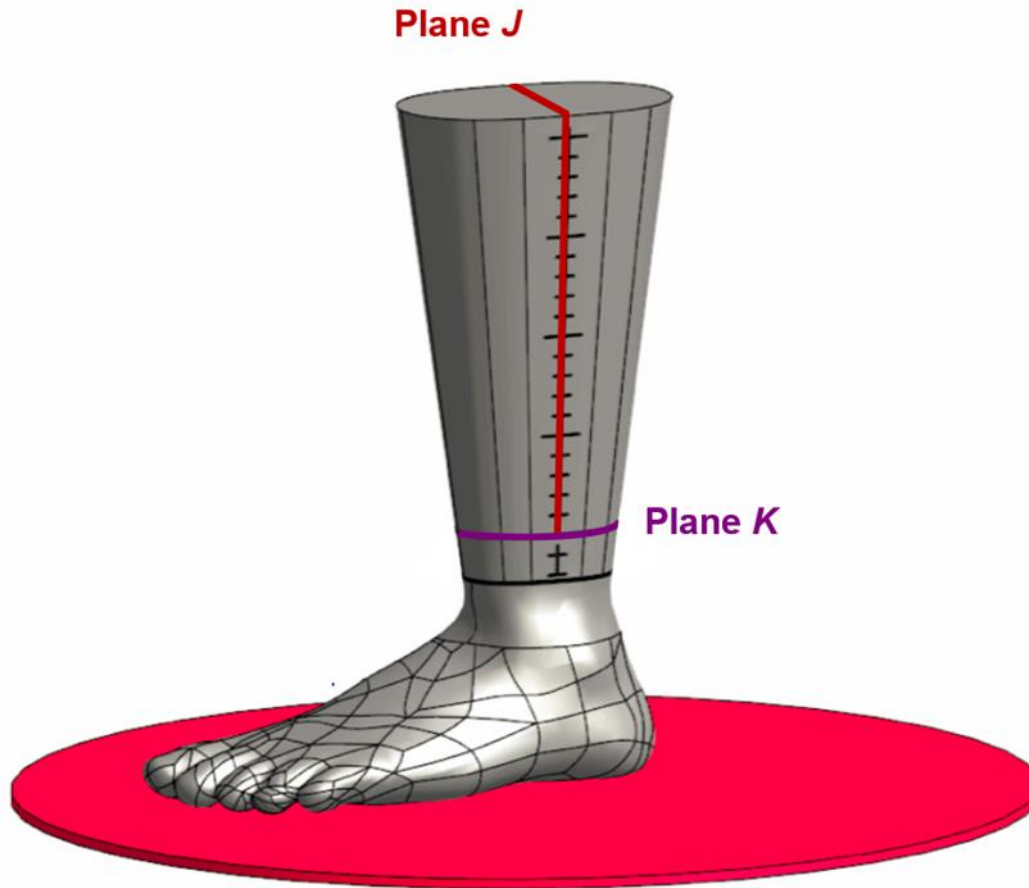

Figure 2.5.2-1 Definition of Plane J and Plane K on the Ankle Phantom

Use the positioning guidelines defined for wrist-worn devices in Section 2.3.2 replacing the wrist-worn device with the ankle-worn device and using the definitions of Plane J and Plane K from Figure 2.5.2-1. The display up direction shall be parallel to the +z axis of the ankle phantom.

If the ankle-worn device doesn't have a display, then define virtual Plane B such that it cuts through the center of the device on the V-axis and is perpendicular to the V-axis, as shown in Figure 2.3.2-4 for a wrist-worn device. If there is an up direction for the device with no display (e.g. text on the face of the device), then align the up direction with the +z axis of the ankle phantom. If there is no indication of an "up" direction for the device, then the manufacturer shall declare the up direction that will be aligned with the +z axis of the ankle phantom.

If an ankle-worn device is too large to lay flat against the conical section of the ankle phantom, then shift the target test position just high enough on the conical section until the device can lay flat against/parallel to the conical section. Because the ankle phantom changes shape from a conical section to a more anatomically correct shape below Plane K, larger devices will need to be shifted upward to keep the device flat against/parallel to the conical section and those devices will touch the bump in the ankle phantom (e.g. lateral malleolus). Note the height of the adjusted target test position in the test report.

## 2.6 Positioning Requirements Notebook and Tablet

### 2.6.1 Device Under Test – Setup

The DUT shall be tested in an idle state and shall be configured as follows (as it applies). The manufacturer shall provide instructions to the ATL for placing the DUT in this state.

- Display:
  - Angled for a notebook  
⇒110 ±5° from the leveled base to the front of the display LCD (Liquid Crystal Display).  
⇒Or manufacturer's locked position closest to 110°.
  - Parallel to the X-Y plane for a tablet
- Transmitting radios:
  - WWAN - On
  - WLAN (Wireless Local Area Network)- Off
  - Bluetooth™ - Off
  - WiMAX™ - Off
  - UWB (Ultra Wideband)- Off
  - All other embedded transmitting radios that are not being tested - Off
- Power Management Settings
  - Screensaver - None
  - Turn Off Display - Never
  - Turn Off Hard Drive - Never
  - System Hibernate - Never
  - System Standby - Never
- Display (LCD) Backlight - Medium intensity (50% or equivalent)
  - Ambient light sensor - Disabled
- Keyboard Backlight - Off
  - Ambient light sensor - Disabled
- Powered by the battery (standard battery only)

- Dynamic control or throttling of CPU and bus clock frequencies - Disabled, if possible.
  - May be accomplished via Microsoft® Windows power profile settings (e.g., Microsoft® XP “Always On” power scheme and Microsoft® Vista “Max Performance” power plan). The Microsoft® Windows power profile must not override the Power Management settings identified above (display, hard drive, etc.)
  - Device manufacturer to provide ATL with specific guidance
- As required, a user-configurable WWAN antenna will be positioned in accordance with the manufacturer's recommended configuration.

### 2.6.1.1 Free Space Test Fixture

If a fixture is required to mount the DUT to the positioning system, the DUT holding fixture shall be made of a material with a dielectric constant of less than 5.0, and loss tangent less than 0.05. The fixture shall not extend beyond the footprint of the DUT by more than 20 mm, and shall be no more than 20 mm in thickness. It is recommended, but not required, that a Styrofoam spacer be used between the holding fixture and the DUT. For systems where no holding fixture is required, a spacer made of expanded polystyrene may be used to raise the DUT to the required height.

### 2.6.2 Chamber Placement

To minimize the physical volume occupied by the DUT during testing, the center of rotation shall be the three-dimensional geometric center of the DUT. In the case of an open notebook, this will typically be a point in space above the keyboard and in front of the display.

This section describes a suggested procedure to locate the geometric center of rotation for notebook and tablet form factors. This procedure has been verified to produce repeatable positioning within a margin of  $\pm 10$  mm in all dimensions. For distributed-axes systems, the procedure assumes the availability of a laser crosshair system in the chamber. The laser is required to have a vertical and horizontal beam such that the intersection of the beams passes through the origin of the chamber coordinate axes.

For combined-axes systems, laser guides are not required, since the pedestal assembly constrains the dimensions in which the DUT may be positioned. However, this procedure assumes that the range pedestal is properly aligned such that the phi and theta rotational axes intersect at a point in space precisely above the theta turntable hub. It also assumes that the rotational center of the theta turntable is clearly and precisely marked. Alignment of the DUT with the theta axis of the pedestal can be accomplished by means of a plumb line or laser level (capable of projecting a plumb line) placed on the turntable at its center of rotation.

### 2.6.3 Positioning a Notebook Relative to the Chamber Coordinate System

The reference plane for the DUT is defined as the plane on which the base of the DUT sits. This plane will be normal to the phi axis of the chamber.

Before placing the DUT in the chamber, place the notebook on a level surface and with the notebook open, with an angle of  $110^\circ$  between the LCD display and the level surface, locate and mark the points labeled A to H in [Figure 2.5.3-1](#). Care should be taken to ensure that the display of the Notebook does not move outside of the  $110$  degree  $\pm 5$  degree allowed limits. It may be necessary to fix the angle of the display with RF transparent EPS (Expanded Polystyrene foam or Styrofoam), using the minimum amount necessary to perform the support function.

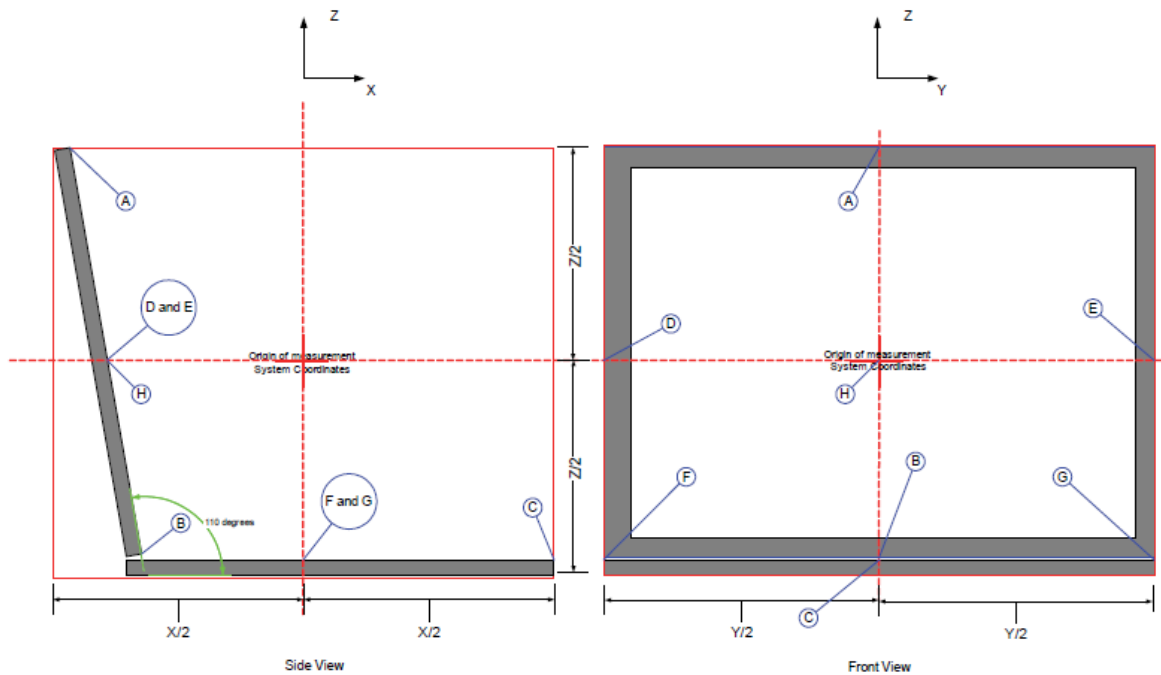

Figure 2.6.3-1 Position of Notebook Relative to the Chamber Coordinates

Point H is at the intersection of lines joining points A to B and D to E and is on the face of the LCD

#### 2.6.3.1 Distributed Axes, Conical Cut Chamber

1. Place the notebook on the central plinth with the LCD, +X DUT axis, facing in the  $\phi = 0^\circ$ ,  $\theta = 0^\circ$  direction. With the assumption that the chamber laser crosshair system is directed in the  $\phi = 270^\circ$ ,  $\theta = 90^\circ$  direction, rotate the azimuth table to the  $\phi = 270^\circ$  position. Adjust the height of the table so that the horizontal beam of the crosshairs intersects point H.
2. Adjust the position of the notebook along the DUT Y-axis so that the vertical laser beam intersects with points A, B, C and H.
3. Rotate the chamber azimuth table back to the  $\phi = 0^\circ$  position and adjust the notebook along the DUT X-axis so that the vertical laser beam intersects points F and G. If necessary, place an object behind the DUT at point F to observe the location of the vertical laser beam.
4. Rotate the azimuth table back to the  $\phi = 270^\circ$  position and recheck the alignment. Repeat if necessary.

If the chamber laser crosshair system is orientated differently, adjust the above procedure appropriately.

#### 2.6.3.2 Combined-Axes, Great Circle Chamber

1. Mount the notebook base on to the  $\phi$  positioner such that the  $\phi$  axis of rotation is centered at the intersection of the lines joining points B to C and F to G. With this intersection point clearly marked on the base of the notebook, it should be possible to accomplish this without any special aids.



2. Rotate the DUT about the phi axis until the notebook's X direction faces vertically downward (display facing down).
3. Adjust the pedestal along the phi axis until Point H is aligned with the theta axis, as verified by the plumb line or laser level. Any misalignment in the Y direction (theta axis does not intersect the line joining A to B) indicates inaccurate positioning about the phi axis.

#### 2.6.4 Positioning a Tablet Relative to the Chamber Coordinate System

For tablet form factors, it is assumed that the display faces in the +Z direction and the +X direction points towards the expected user position. For example, [Figure 2.5.4-1](#) illustrates this for a rectangular tablet with display configured to be used in the "portrait" orientation. Since this class of device often supports multiple display orientations, the manufacturer shall submit photographs or drawings to the ATL indicating the assumed DUT reference coordinate system. These illustrations shall also be included in the test report.

Before placing the DUT in the chamber locate and mark the points labeled A to K shown in [Figure 2.5.4-1](#).

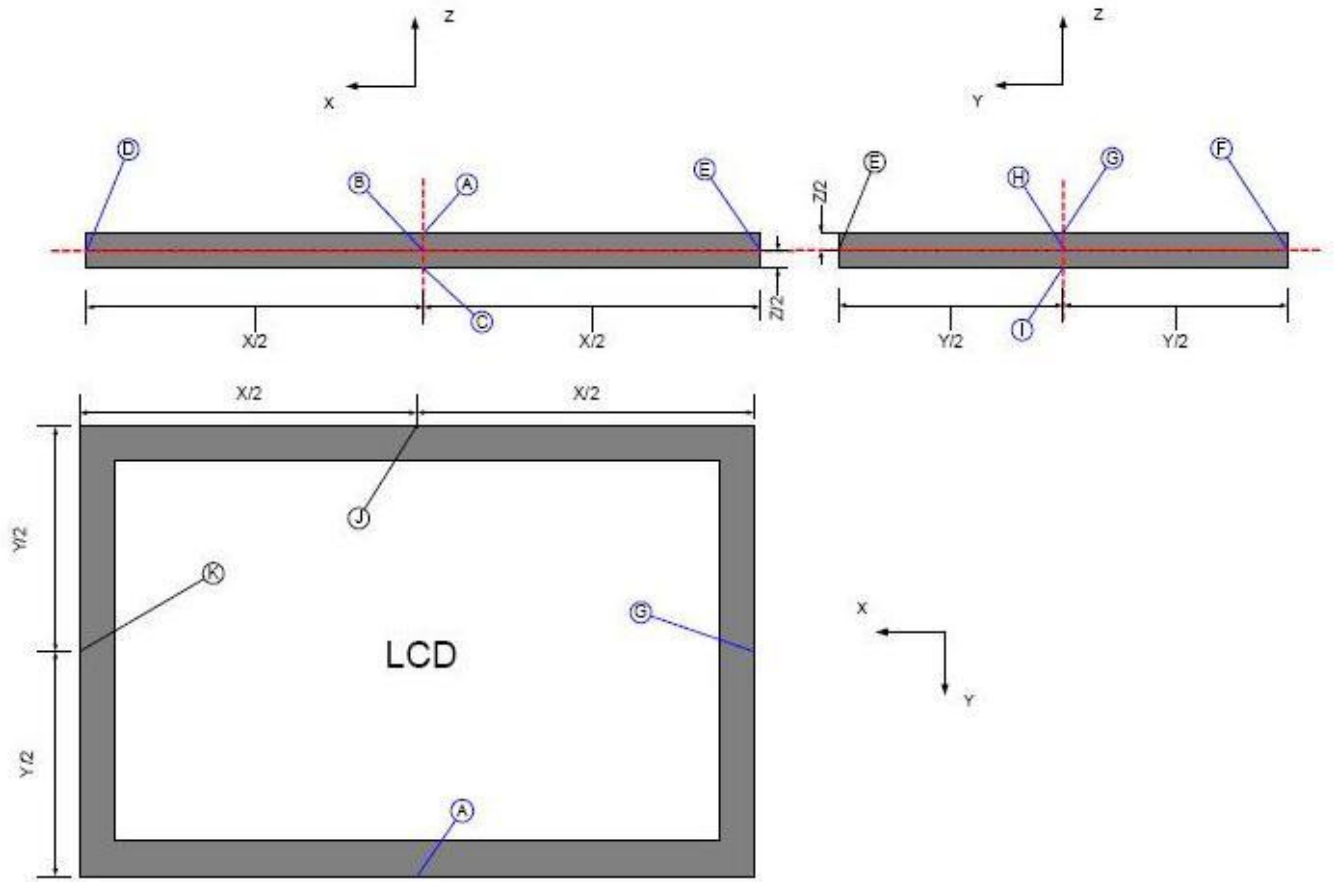

Figure 2.6.4-1 Position of Tablet Relative to the Chamber Coordinates

### 2.6.4.1 Distributed Axes, Conical Cut Chamber

1. Place the tablet on the central plinth with the +X DUT axis facing in the  $\phi = 0^\circ$ ,  $\theta = 0^\circ$  direction. With the assumption that the chamber laser crosshair system is directed in the  $\phi = 270^\circ$ ,  $\theta = 90^\circ$  direction, adjust the height of the tablet so that the horizontal beam of the crosshairs intersects point B.
2. Adjust the position of the tablet along the DUT X-axis so that the vertical laser beam intersects points A, B, C and J. If necessary, place an object behind the DUT at point J to observe the location of the vertical laser beam.
3. Rotate the chamber azimuth table to the  $\phi = 90^\circ$  position and adjust the tablet along the DUT Y-axis so that the vertical laser beam intersects points G, H, I and K. If necessary, place an object behind the DUT at point K to observe the location of the vertical laser beam.
4. Rotate the azimuth table back to the  $0^\circ$  position and recheck the alignment. Repeat if necessary.

If the chamber laser crosshair system is orientated differently, adjust the above procedure appropriately.

### 2.6.4.2 Combined-Axis, Great Circle Chamber

1. Mount the DUT base on to the phi positioner such that the phi axis of rotation is centered at the intersection of the lines joining points A to J and G to K. With this intersection point clearly marked on the base of the tablet, it should be possible to accomplish this without any special aids.
2. Rotate the DUT about the phi axis until the tablet Y direction faces vertically downward.
3. Adjust the pedestal along the phi axis until Point B is aligned with the theta axis, as verified by the plumb line or laser level.
4. Rotate the DUT about the phi axis until the tablet X direction faces vertically upward.
5. Verify that Point H is aligned with the theta axis based on the plumb line or laser level. Any misalignment indicates inaccurate positioning about the phi axis.

## 2.7 Positioning Requirements Integrated Device

### 2.7.1 Device Under Test – Setup

The DUT shall be tested in a normal operating state, but shall be configured as follows (as it applies). The manufacturer shall provide instructions to the ATL for placing the DUT in this state.

- Transmitting radios:
  - WWAN - On
  - WLAN (Wireless Local Area Network) - Off
  - Bluetooth™ - Off
  - UWB (Ultra Wideband) - Off
  - All other embedded transmitting radios that are not being tested - Off
- Power Settings

- Device should be placed into normal operating mode (minus the radio configuration as explained above)
- Power by battery, if possible, to reduce interference (standard manufacturer's battery)
- Power by AC/DC power supply when needed using manufacturer's settings and current draw
- (ensure to take care when using a power cord: avoid the antenna and power cord coming in close proximity of each other, if possible, and placing the power cord in ferrite tubing can help reduce RF interference).
- Device manufacturer to provide ATL with specific guidance.
- As required, a user-configurable WWAN antenna will be positioned in accordance with the manufacturer's recommended configuration (see *CTIA 01.01 [1]*) for further information)
- Attachment of Additional DUT Accessories (i.e., non-antenna accessories)
  - Accessory(ies), if needed, will be attached and positioned on or around the DUT according to the manufacturer's recommended configuration. This recommended configuration must be representative of normal use of the DUT and be maintained by the ATL during all testing of that DUT.
  - Reasonable effort shall be taken to maintain the quiet zone or at least minimize the impact on the quiet zone.
  - Photographs of sufficient detail of the set-up shall be included in the test report to enable the reproduction of the tests.

### 2.7.2 Free Space Fixturing

The integrated device or integration component may be held in the defined free space position by a custom designed holding fixture. The holding fixture shall be made of a material with a dielectric constant of less than 5.0, and loss tangent less than 0.05. The fixture shall not extend beyond the footprint of the integrated device by more than 20 mm, and shall be no more than 20 mm in thickness.

### 2.7.3 Considerations for Externally-powered Devices

In the case of all devices that utilize an external power cable as part of the intended final market application, the cable shall be considered part of DUT (equipment under test). The device manufacturer should provide guidance on the positioning of such cables so that they do not cause cross coupling or introduce unwanted noise within their device throughout the test process.

The ATL shall ensure the following:

- All external cables are secured in such a way that the cables remain in the same position throughout the rotation of the device.
- Any external power sources are free from noise and that the source does not affect the RF performance of the equipment under test

The ATL shall use the appropriate chamber type; some combined-axes systems are unsuitable in keeping cable movement to a minimum. The ATL shall test in the primary mechanical mode only.

Devices that are externally powered are categorized as follows:

- Internal power supply with external continuous power requirements
- The DUT should be tested with the manufacturer-supplied cable and power supply assembly. The test chamber power source shall be stable, isolated, free from any influencing noise and placed to minimize degradation of the quiet zone.

The ATL shall maintain supporting evidence that the power source utilized throughout the testing meets the above criteria.

- External power requirements such as automotive devices
- The manufacturer should supply a suitable automotive type cable together with the voltage and current requirements.  
The power source shall be free from any noise or switching frequencies that may cause any form of self-interference that may have an impact of measurement accuracy.

The ATL shall maintain supporting evidence that the power source utilized throughout the testing meets the requirements of the above criteria.

- USB-powered Devices  
The manufacturer shall supply a USB cable together with a charging source that is a market application of the product. Where the manufacturer does not supply a USB cable, the ATL shall utilize a suitable cable and charging/power source which shall be isolated and free from any noise that may influence the accuracy of the test results. Any charging/ power source that is utilized shall be placed within the chamber to minimize degradation of the quiet zone.

The ATL shall maintain supporting evidence that the power source utilized throughout the testing meets the requirements of the above criteria.

- Battery-powered devices that would require an external power source to maintain a TRP/ TIS test

When the device has insufficient power capacity to maintain the cellular link for at least 50% of the execution time of a single channel TRP or TIS test, the ATL should then advise the customer that the charging cable will be utilized throughout the test process. The cable shall be free from any noise that may influence the accuracy of the test results, with the use of ferrites/chokes highly recommended. The power source that is utilized within the chamber shall be placed such that degradation to the quiet zone is minimized.

The ATL shall maintain supporting evidence that the power source utilized throughout the testing meets the requirements of the above criteria.

#### 2.7.4 Integrated Device Chamber Placement

To minimize the physical volume occupied by the DUT during testing, the center of rotation shall be the three-dimensional geometric center of the DUT and not the antenna.

### 2.7.5 Positioning an Integrated Device Relative to the Chamber Coordinate System

The reference plane for the DUT is defined as the plane on which the base of the DUT sits. This plane will be normal to the phi axis of the chamber.

Before placing the DUT in the chamber, place the integrated device on a level surface and measure the height, width and depth ( $H$ ,  $W$ ,  $D$ ) of the device to determine the center of each (mark with tape if need). The center of the height, width and depth of the device shall be located at the origin of the chamber coordinate system.

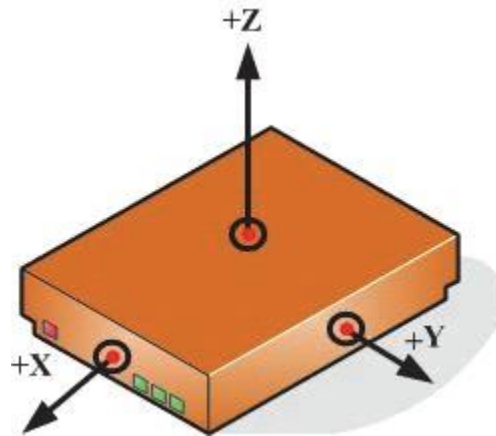

Figure 2.7.5-1 Internal Antenna

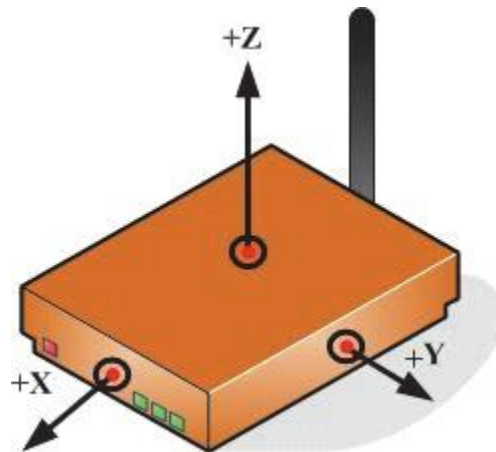

Figure 2.7.5-2 Direct Connect External Antenna (It does not matter where the antenna is located as you will center on the device)

## 2.7.6 Positioning an Integrated Device with a Removable Antenna Connected Directly to the Device via an RF Transmission Line (Such as a Coaxial Cable) Less Than 20 cm in Length

Due to the numerous possible configurations of this device type, the ATL will work with the vendor to determine the best possible configuration(s) (multiple if needed) of the device in the chamber to be tested. The ATL will need to take care in documenting this in the report. This will include but will not be limited to the following:

- Vendor shall work with the ATL, and or define the configuration for the ATL to perform the test plan in a consistent manner.
- Taking picture of the set-up so it can be clearly understood how the device was configured in the chamber.
  - Identify the center point of the chamber and clearly mark a cross-hair using the right hand rule on each image taken in the chamber.
  - Identifying, documenting and maintaining the distances between cables (e.g., power cord(s), antennas, etc.) throughout the measurements which can have an effect on the radiated performance of the testing.
- Each piece of equipment (e.g., Antenna(s), power cords, etc.) used during testing shall be marked and documented, at minimum, in the ATL report to reduce variables upon retest.
  - This equipment and only this equipment shall be used if any additional testing is needed.

## Section 3 MIMO Chamber Specific DUT Orientation Conditions

### 3.1 Scope

This section lists the normative DUT orientation conditions for all DUT types relevant to MIMO and transmit diversity OTA testing. Additional orientation conditions will be added to this document as they become normative.

### 3.2 Testing Environment Conditions

Table 3.2-1 below lists the testing environment conditions along with a diagram and applicable references. Section 3.5.2 defines the Euler rotation angles in three-dimensional space. The reference coordinate system and orientation of devices in that coordinate system is shown in Figure 3.2-1 below, which includes the mechanical alignment of a phone. For tablets, the home button, charging connector and similar components can be used to define top and bottom. In the case of methodologies utilizing a spatial channel model in Figure 3.2-1, the X axis points towards the channel model reference 0 degree location. For tablets or other DUTs with no clear features that can help to distinguish top and bottom, a manufacturer declaration shall be used to define the top and bottom of the device.

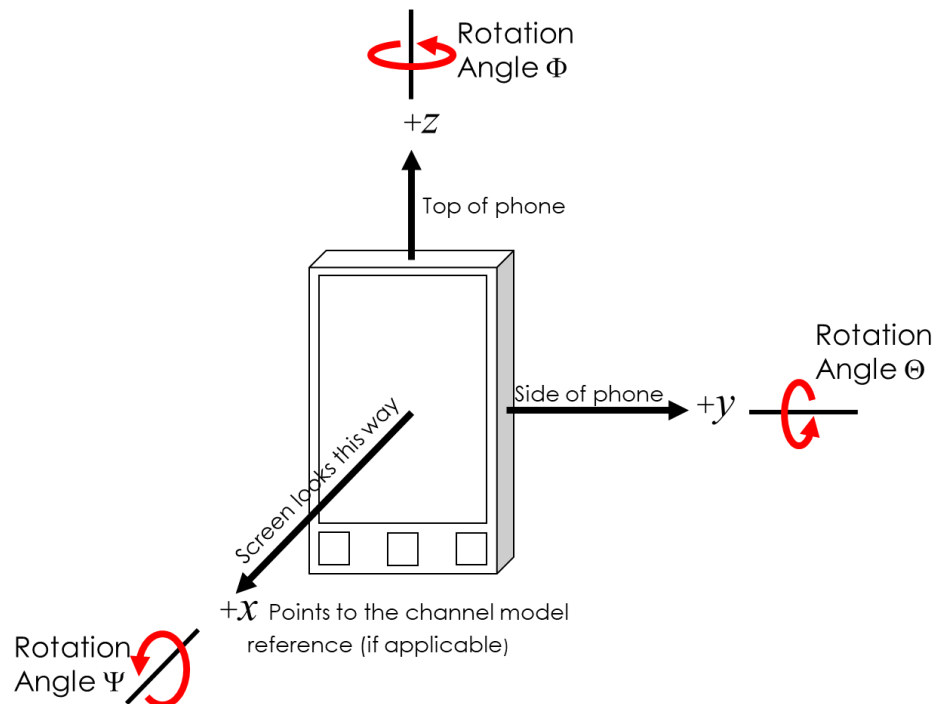

Figure 3.2-1 Reference Device Orientation

For the landscape case, the antenna positions relative to the channel will be different and the interaction of any future-defined phantoms with the antennas will depend on its orientation as shown in Figure 3.2-2.



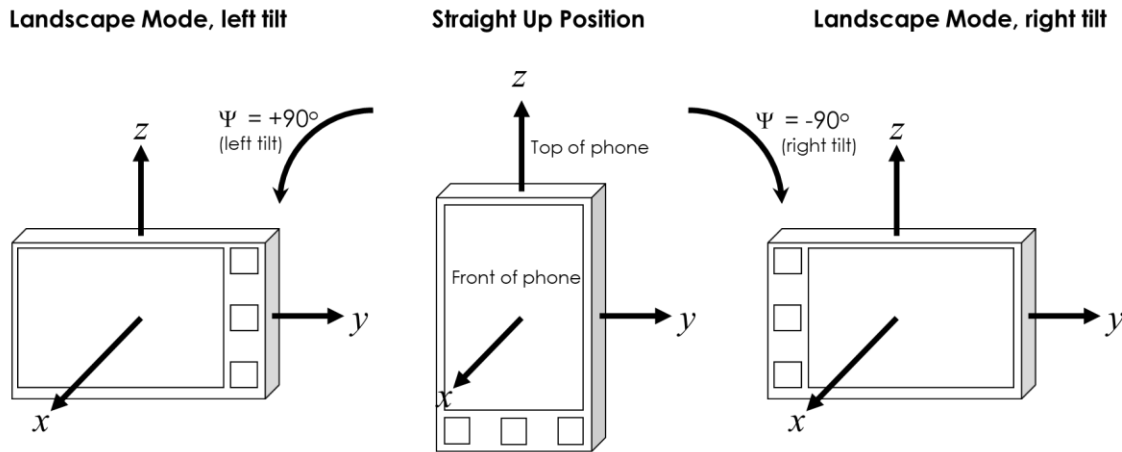

Figure 3.2-2 Left and Right Tilts for Landscape Mode Relative to Portrait Mode Shown to Interact Differently with the Antennas Depending on the Tilt

The usage mode of an DUT indicates how it relates to its environment. This includes the following example use cases: free space, beside head, beside head and hand, hand only etc. Since to date only isotropic metrics have been used (TRP/TIS) the definition of positioning the device for a certain use case has been equivalent to orienting it relative to the environment. With the introduction of spatial channel models, the positioning for a specific use case has to be separated from the actual orientation relative to the spatial incoming signals.

The DUT orientation angle in three-dimensional space is defined using the three Euler angles –  $\Psi$ -(rotation around the x axis);  $\theta$ -(rotation around the y axis);  $\phi$ -(rotation around the z axis) as defined in: *Antennas In Real Environments* [4] and linked to the reference coordinate systems and reference orientation from Figure 3.2-1 and Figure 3.2-2 above. Due to the non-commutative nature of 3D rotations of DUTs, the order of rotations needs to be specified clearly. The following order of rotations needs to be followed for the device orientations specified in this test plan:  $\Psi$  (rotation around the x axis)  $\rightarrow$   $\theta$  (rotation around the y axis)  $\rightarrow$   $\phi$  (rotation around the z axis).

After positioning the DUT in its initial position for a specific testing condition (note that DUT positioning guidelines inside the MIMO OTA test zone described in Section 3.3 shall be followed), labs implement the rotation of the DUT defining a vector of Euler angles as shown in Table 3.2-1 below.

Table 3.2-1 Normative Testing Environment conditions for Devices Supporting DL MIMO Data Reception

DUT Type and Dimension	Usage Mode	Testing Condition	DUT Orientation Angles	Diagram	Notes
Handset and Tablet, any size	Data mode portrait (DMP)	Free space DMP	$\Psi = 0$ ; $\theta = -45$ ; $\phi = 0$	Figure 3.2-1 plus adjusting for DUT Orientation Angles	1
Handset and Tablet, any size	Data mode landscape (DML)	Free space DML - Right Tilt	$\Psi = -90$ ; $\theta = -45$ ; $\phi = 0 - right\ tilt$	Figure 3.2-1 plus adjusting for DUT Orientation Angles	1, 2

DUT Type and Dimension	Usage Mode	Testing Condition	DUT Orientation Angles	Diagram	Notes
Handset and Tablet, any size	Data mode landscape (DML)	Free space DML - Left Tilt	$\Psi = -90;$ $\theta = -45;$ $\Phi = 0 - \textit{left tilt}$	Figure 3.2-1 plus adjusting for DUT Orientation Angles	1, 2
Handset and Tablet, any size	Data mode screen-up (DMSU)	Free space DMSU	$\Psi = 0;$ $\theta = -90;$ $\Phi = 0$	Figure 3.2-1 plus adjusting for DUT Orientation Angles	1

**Note 1:** Rotation is defined in Euler rotation angles, where  $\Psi$  denotes rotation around the X axis (yaw),  $\theta$  denotes rotation around the Y axis (pitch), and  $\Phi$  denotes rotation around the Z axis (roll) from *Antennas In Real Environments* [4]. The order of rotation angles listed in the DUT Orientation Angles column corresponds to the necessary order of rotations.

**Note 2:** Left/right/both hand phantoms for the DML usage scenario are not currently defined in 3GPP or CTIA; until these phantom designs become available, it is possible to only define a DML usage scenario in free space.

The data mode portrait (DMP) conditions are defined in Table 3.2-1. The data mode landscape (DML) testing conditions are not currently defined in any standard testing methodology but benefit from a thorough treatment in academic literature, for example, *Antennas In Real Environments* [4]. Currently, CTIA utilizes free space as the normative test condition for all handset and tablet sizes until a DMP and a DML phantom design becomes available, at which time the normative testing conditions described in this document will be updated.

### 3.3 DUT Positioning within the MPAC Test Volume

#### 3.3.1 DUT Free-Space Orientation within the MPAC Test Zone

In order to minimize measurement uncertainty, it is important that ATLS ensure the DUT is oriented within the chamber's test zone in a standardized manner. Table 3.2-1 provides a preliminary set of normative DUT orientation conditions and the informational DUT orientation conditions are found in Section 3.5. MIMO OTA performance testing of handsets and tablets in free-space shall use the normative device orientations shown in Table 3.2-1. DMP and DML - Right Tilt shall be tested in all normative operating bands, as required, in Sections 3.3.3, 3.3.3.1 and 3.3.3.2. Testing in DML - Left Tilt and DMSU shall be limited to all normative operating bands below 1 GHz, as required, in Section 3.3.3.1. The MIMO OTA performance assessment of notebooks is not currently normative, and this device type is included in Section 3.5.

Labs shall confirm the direction of rotation and rotate the DUT about its Z axis in 30-degree phi angle increments, beginning with the DUT's +X Axis oriented at phi =0 degrees. The DUT shall be situated in DMP FS, DML FS, and DMSU FS testing conditions, as shown in Table 3.2-1 such that its Z axis is perpendicular to the turntable with the +Z axis facing away from the turntable. Device positioning requirements are specified in Section 3.3.3.

#### 3.3.2 MPAC DUT Orientation within the Test Zone using Phantoms

The use of phantoms during the execution of MIMO OTA tests using the MPAC approach is FFS.

### 3.3.3 Maximum DUT Antenna Spacing and Placement of DUT within the Test Zone

In order for the MPAC system to emulate the intended propagation statistics within the region of space incident on the DUT antennas, two aspects determine the associated antenna spacing and positioning guidelines. The maximum antenna spacing in the DUT shall be within the limit determined by the MPAC system's ability to emulate the spatial correlation function and the power stability of the field incident on the DUT antennas as previously verified as part of the system validation utilizing the channel model validation procedures in Section 4.2 of *CTIA 01.40* [5]. The DUT shall wholly reside within the 300mm ripple zone as defined in Section 2.2.1 of *CTIA 01.40* [5] under all DUT positioning conditions.

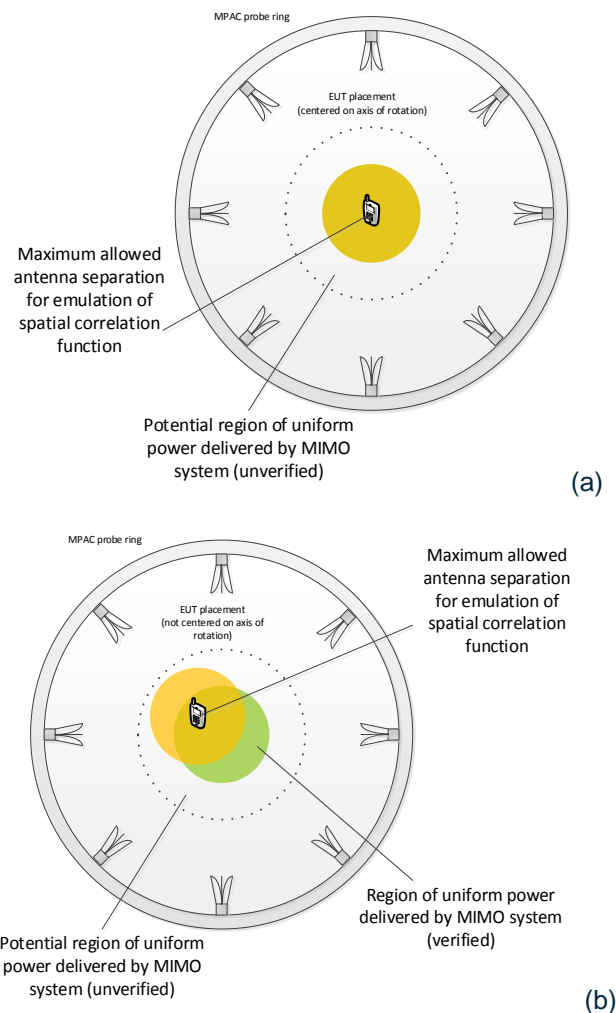

Figure 3.3.3-1: Illustration of DUT Antenna Spacing and Positioning Guidelines, (a) Guideline in this Test Plan, (b) Example with DUT Meeting the Maximum Allowed Antenna Separation but not Within the Verified Power Stability Region

The maximum antenna spacing in the DUT shall be defined as one wavelength at the center frequency of the middle channel of the downlink for the band under test (refer to Section 5 in *CTIA 01.40* [5]). Testing is not required in any band where the maximum antenna spacing is greater than one wavelength. For LTE 4 RX devices where the antenna separation of any two antennas exceeds one wavelength, 2x2 MIMO testing is not required for that band. A verification of power stability can be derived from the spatial correlation verification results in Section 4.2.3 of *CTIA 01.40* [5]. Given that this verification spans a region with a diameter of one wavelength centered on the axis of rotation in the chamber, the region where DUT antennas shall be placed (the MIMO OTA test zone) shall be defined in the same way (see

Figure 3.3.3-1) provides an example of a DUT meeting the maximum allowed antenna separation but not within the verified power stability region; this placement of a DUT shall not be used. The optimization of the maximum allowed antenna spacing of the DUT as well as the verification of the test zone is expected as part of future work.

The DUT maximum antenna spacing and placement within the test zone shall be defined by the following two-tier methodology.

#### 3.3.3.1 DUT Placement, Frequency of Operation < 1GHz

When operating in frequency bands lower than 1GHz, the physical center of the DUT shall be placed in the chamber center, the DUT shall be completely contained within the volume defined by the respective operating band equivalent to a sphere with a radius equal to half wavelength as defined in Section 5.1 of *CTIA 01.40* [5] for normative bands. Dimensional information for other bands that may be considered by other certification bodies can be found in Section 5.2 of *CTIA 01.40* [5].

#### 3.3.3.2 DUT Placement, Frequency of Operation > 1GHz

When operating in frequency bands higher than 1 GHz the equidistant physical point between the DUT MIMO antenna system shall be placed in the chamber center following guidance defined in Figure 3.3.3.2-1 and the DUT MIMO antenna system (further physical dimension or both antennas maximum E-field regions) shall be completely contained within the volume defined by the respective operating band equivalent to a sphere with a radius equal to half wavelength defined in Section 5.1 of *CTIA 01.40* [5] for normative bands. Dimensional information for other bands that may be considered by other certification bodies can be found in Section 5.2 of *CTIA 01.40* [5]. The definition of the equidistant point between the DUT MIMO antennas shall be provided through manufacturer declaration. The manufacturer shall mark the equidistant point on the DUT for each operating band greater than 1 GHz such that the test laboratory has a clear indication for DUT positioning purposes.

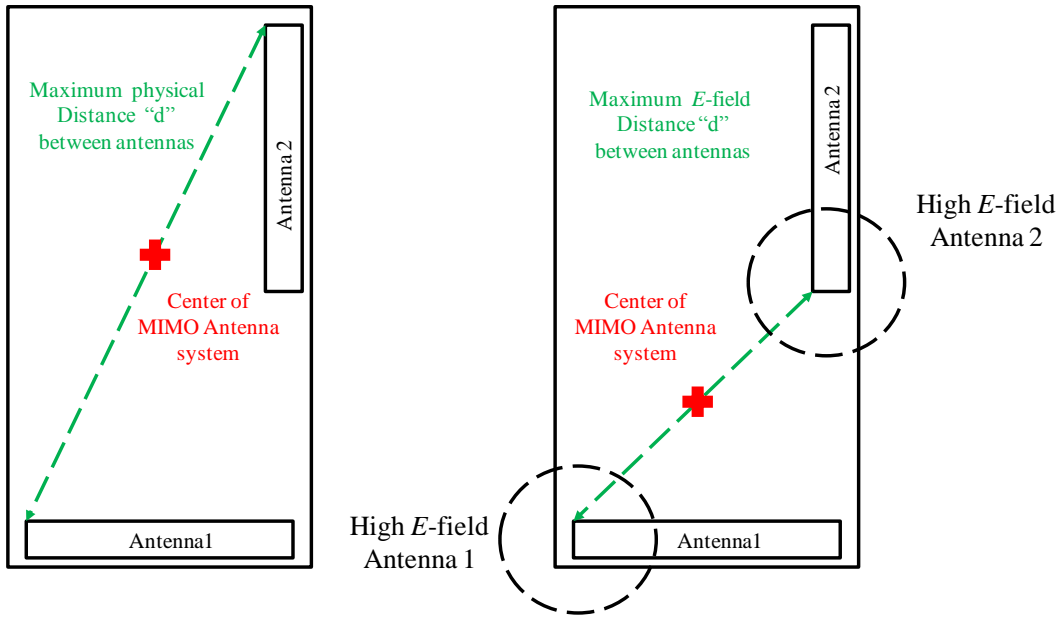

Figure 3.3.3.2-1 Definition of Distance between MIMO Antennas and DUT Center, Maximum Physical Separation, or E-field Maximum Separation Defined by Manufacturer

### 3.4 DUT Positioning within the RTS Test Volume

#### 3.4.1 DUT Free-Space Orientation within the RTS Test Zone

In order to minimize measurement uncertainty, it is important that ATLS ensure the DUT is oriented within the chamber's test zone in a standardized manner. Section 3.2 provides a preliminary set of normative DUT orientation conditions and the informational DUT orientation conditions are found in Section 3.5. MIMO OTA performance testing of handsets and tablets in free-space shall use the normative device orientations shown in Table 3.2-1. DMP and DML - Right Tilt shall be tested in all normative operating bands, as required, in Sections 3.3.3, 3.3.3.1 and 3.3.3.2. Testing in DML - Left Tilt and DMSU shall be limited to all normative operating bands below 1 GHz, as required, in Section 3.3.3.1. The MIMO OTA performance assessment of notebooks is not currently normative, and this device type is included in Section 3.5.

Labs shall confirm the direction of rotation and rotate the DUT about its Z axis in 30-degree phi angle increments, beginning with the DUT's +X Axis oriented at phi =0 degrees. The DUT shall be situated in DMP FS, DML FS, and DMSU FS testing conditions, as shown in Table 3.2-1 such that its Z axis is perpendicular to the turntable with the +Z axis facing away from the turntable. Device positioning requirements are specified in Section 3.3.3.

#### 3.4.2 RTS DUT Orientation within the Test Zone using Phantoms

The use of phantoms during the execution of MIMO OTA tests using the RTS approach is FFS.

#### 3.4.3 Maximum DUT Antenna Spacing and Placement of DUT within the Test Zone

Unlike the MPAC approach, the RTS approach does not require special considerations of the maximum antenna spacing and placement within the test zone since the spatial correlation behavior of the RTS methodology follows the theoretical curve more closely for larger antenna separations. Therefore, the same positioning guidelines as for SISO OTA testing apply to RTS for the first stage. Generally, it should be assumed that the second stage of the RTS method, which involves a cable replacement radiated connection, is performed in the same anechoic chamber as the first stage antenna pattern measurement. The use of a different chamber for the second stage is not precluded but would require a recalculation of the impact of any difference between the anechoic chambers.

### 3.5 MIMO Chamber Specific DUT Orientation Conditions (Informative)

#### 3.5.1 Scope

This section lists the informative DUT orientation conditions for all DUT types relevant to MIMO and transmit diversity OTA testing. The diagrams included in Section 3.2 and Section 3.3 may also be useful for gaining further familiarity with the spatial coordinate system utilized in Section 3 of this document.

#### 3.5.2 Testing Environment Conditions

The reference coordinate system and orientation of devices in the coordinate system is described in Section 3 of this document and in this section. For Notebooks, the definitions specified in Section 2.5 are used. In the case of methodologies utilizing a spatial channel model, the X axis points towards the channel model reference 0 degree location. For other DUT device types with no clear features that can help to distinguish top and bottom, a manufacturer declaration may be used to define the top and bottom of the device.

The principal antenna pattern cuts called for in this Appendix (XY plane, XZ plane, and YZ plane) are defined in IEEE 149-1979.R2008 [7]. The XY plane cut corresponds to the absolute throughput testing condition applied to the CTIA reference antennas for test plan development as part of the Inter-Lab/Inter-Technique test effort. They XZ plane and YZ plane cuts are shown for completeness and are not required

for the absolute data throughput framework. The YZ plane cut corresponds to a device positioned with its screen up in a USB/WLAN tethering scenario and may be a useful testing point for handset devices expected to achieve performance metrics under such usage conditions.

The DUT orientation angle in three dimensional space is defined using the three Euler angles –  $\Psi$ -yaw;  $\theta$ -pitch;  $\phi$ -roll as defined in *Antennas In Real Environments* [4] and linked to the reference normative coordinate systems and reference orientations.

After positioning the DUT in its initial position for a specific testing condition (note that DUT positioning guidelines inside the MIMO OTA test zone described in Section 3.3.3 shall be followed), labs implement the rotation of the DUT defining a vector of Euler angles as shown in the example below:

**EXAMPLE:** Consider a DUT measured in an anechoic chamber as described in Section 2 of CTIA 01.40 [5].

To measure the free space use case in the YZ plane (for example, at every 30 degrees), the rotation vectors would be as follows:

$\Psi = [0\ 0\ 0\ 0\ 0\ 0\ 0\ 0\ 0\ 0\ 0\ 0]$  - a vector of 12 zeros indicating no rotation from the reference position for any phi value below

$\theta = [-90\ -90\ -90\ -90\ -90\ -90\ -90\ -90\ -90\ -90\ -90\ -90]$  – a vector of 12 values equal to -90 indicating a constant tilt of 90 degrees for all phi values below

$\phi = [0\ 30\ 60\ 90\ 120\ 150\ 180\ 210\ 240\ 270\ 300\ 330]$  – a vector of 12 distinct rotations from the reference position representing a rotation along the azimuth plane with a step of 30 degrees.

These vectors unambiguously define that the DUT is to be oriented with the screen up and rotated in azimuth every 30 degrees.

Table 3.5.2-1 Informative Testing Environment conditions for MIMO OTA Testing Using Principal Antenna Pattern Cuts

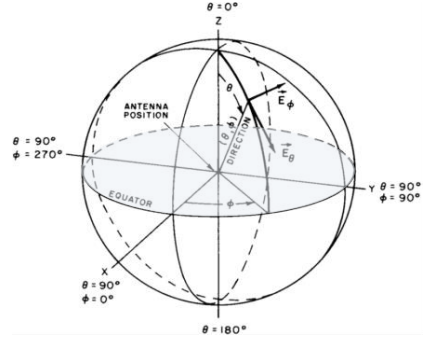
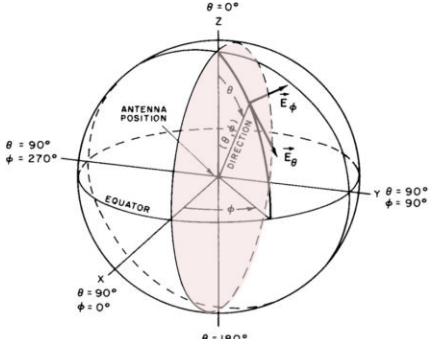
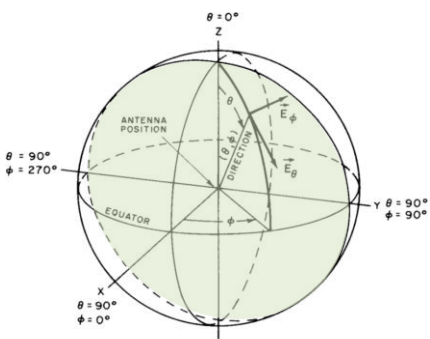
DUT Type and Dimension	Usage Mode	Testing Condition	DUT Orientation Angles	Diagram	Reference/ Notes
CTIA Reference Antennas	Absolute throughput in free space, XY plane	XY plane	$\Psi = 0;$ $\theta = 0;$ $\phi = 0$		IEEE 149-1979.R2008 [7]  Note 1, 2, 3
CTIA Reference Antennas	Absolute throughput in free space, XZ plane	XZ plane	$\Psi = 90;$ $\theta = 0;$ $\phi = 0$		IEEE 149-1979.R2008 [7]  Note 1,2,3
CTIA Reference Antennas	Absolute through-put in free space, YZ plane	YZ plane	$\Psi = 0;$ $\theta = -90;$ $\phi = 0$		IEEE 149-1979.R2008 [7]  Note 1,2,3

**Note 1:** Rotation is defined in Euler rotation angles, where  $\Psi$  denotes rotation around the X axis (yaw),  $\theta$  denotes rotation around the Y axis (pitch), and  $\phi$  denotes rotation around the Z axis (roll) from *Antennas In Real Environments* [4]

**Note 2:** The CTIA reference antennas have been defined for the purposes of comparing MIMO OTA methodologies.

**Note 3:** The absolute throughput usage mode is defined only within the framework of the CTIA reference antennas and is used for comparison of results within/across MIMO OTA methodologies.

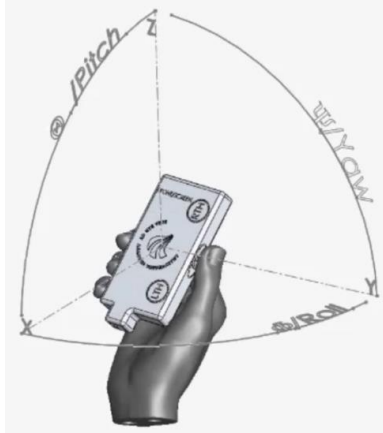
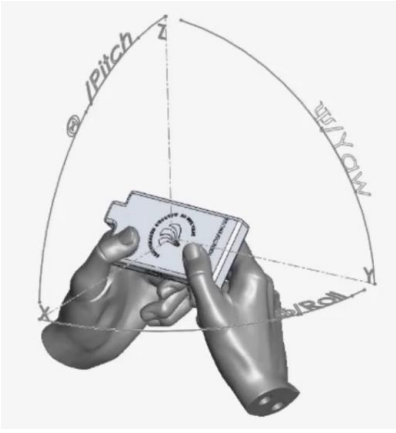

Table 3.5.2-2 Informative Testing Environment conditions for Devices Supporting DL MIMO Data Reception While Using Hand Phantoms

DUT Type and Dimension	Usage Mode	Testing Condition	DUT Orientation Angles	Diagram	Reference/Notes
Handset, width < 56mm	Data mode portrait (DMP)	Left and Right Narrow Data Grip Hand Phantom	$\Psi = 0;$ $\theta = -45;$ $\phi = 0$		<i>Antennas In Real Environments</i> [4]  Note 1
Handset, 56 mm ≤ width ≤ 72 mm		Left and Right PDA Hand Phantom			
Handset, 72 mm < width ≤ 92 mm		Left and Right Wide Grip Hand Phantom			
Handset, any size	Data mode landscape (DML)	Hand Phantom DML (FFS)	$\Psi = 90;$ $\theta = -45;$ $\phi = 0$ - left tilt  $\Psi = -90;$ $\theta = -45;$ $\phi = 0$ - right tilt		<i>Antennas In Real Environments</i> [4]  Notes 1, 2, 3

**Note 1:** Rotation is defined in Euler rotation angles, where  $\Psi$  denotes rotation around the X axis (yaw),  $\theta$  denotes rotation around the Y axis (pitch), and  $\phi$  denotes rotation around the Z axis (roll) from *Antennas In Real Environments* [4]

**Note 2:** Left/right/both hand phantoms for the DML usage scenario are not currently defined in 3GPP or CTIA; until these phantom designs become available, it is possible to only define a DML usage scenario in free space.

**Note 3:** For a symmetric 2D coverage of testing points in azimuth, DML left and right tilts are expected to produce identical results in free space. Once phantom designs become available, we expect the interaction of the phantom with the antennas to be dependent on the tilt.

**Note 4:** Talk mode conditions to facilitate VoLTE testing may be added to this table following further study.

**Note 5:** Where applicable, device positioning in hand phantoms shall follow the existing guidelines given in Section 2.4 of this document.

Table 3.5.2-3 Informative Testing Environment conditions for Notebook Devices Supporting DL MIMO Data Reception

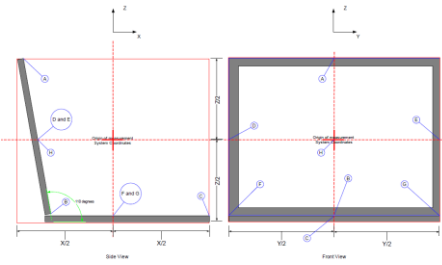
DUT Type and Dimension	Usage Mode	Testing Condition	DUT Orientation Angles	Diagram	Reference/Notes
Notebook	Free space	XY plane	$\Psi = 0;$ $\theta = 0;$ $\phi = 0$	 <p>The diagram illustrates the testing environment for a notebook. It consists of two views: a 'Side View' on the left and a 'Front View' on the right. Both views show a coordinate system with X and Y axes. The side view shows the notebook's profile with a screen opening at a 110-degree angle. The front view shows the top-down layout of the notebook. Various antenna locations are marked with blue circles and labeled with letters (A, B, C, D, E, F, G, H, I, J, K, L, M, N, O, P, Q, R, S, T, U, V, W, X, Y, Z). Dimensions are indicated with red dashed lines and labels like X1, X2, Y1, Y2, Z1, Z2. The testing condition is specified as the XY plane.</p>	Section 2.5 Notes 1, 2
<p><b>Note 1:</b> Rotation is defined in Euler rotation angles, where <math>\Psi</math> denotes rotation around the X axis (yaw), <math>\theta</math> denotes rotation around the Y axis (pitch), and <math>\phi</math> denotes rotation around the Z axis (roll) from <i>Antennas In Real Environments</i> [4]</p> <p><b>Note 2:</b> The 110 degree angle of the notebook screen opening is a standard reference for all measurements of antennas embedded in notebooks; as a result, the notebook measurement in free space is the principal XY plane cut with respect to this reference.</p>					

## Section 4 SISO, Millimeter Wave Test Setup Configurations

### 4.1 Millimeter Wave Positioning Requirements and Reference Coordinate System

Editor's Note: PC1 (FWA) testing is FFS since the MU aspects have not been finalized yet

This section defines the measurement coordinate system for the NR UE. The reference coordinate system is provided in Figure 4.1-1 for the DUT in the default alignment, i.e., the DUT and the fixed system coordinate systems are aligned with  $\Psi = 0^\circ$  and  $\Theta = 0^\circ$  and  $\Phi = 0^\circ$  where  $\Psi$ ,  $\Theta$ , and  $\Phi$  describe the relative angles between the two coordinate systems.

Figure 4.1-1 Reference Coordinate System

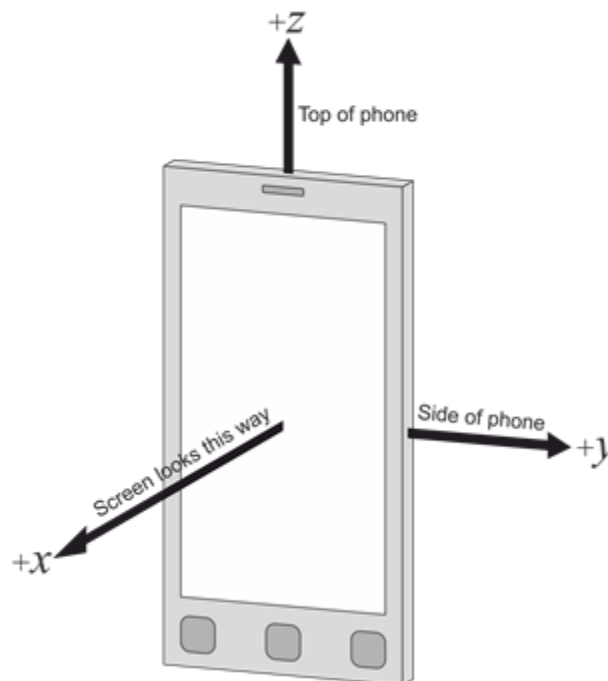

The following aspects are necessary:

- A basic understanding of the top and bottom of the device is needed in order to define unambiguous DUT positioning requirements for the test, e.g., in the drawings used in this appendix, the three buttons are on the bottom of the device (front) and the camera is on the top of the device (back)
- An understanding of the origin and alignment of the coordinate system inside the test system, i.e. the directions in which the x, y, z axes point inside the test chamber, in order to define unambiguous DUT orientation, DUT beam, signal, interference, and measurement angles

Table 4.1-1 through Table 4.1-3 provide the test conditions and angle definitions for three permitted device alignments for smartphones and tablets for the default test condition, DUT orientation 1, and two different options for each permitted device alignment to re-position the device for DUT Orientation 2 outlined in Figure 4.1-2 and Figure 4.1-3. Link and measurement polarizations  $\theta$  and  $\phi$  used below are defined as part of the spherical coordinate system outlined in Section 5.2 of CTIA 01.73 [2].

Table 4.1-1 Millimeter-Wave DUT Test Conditions and Angle Definitions for Smartphones and Tablets for Alignment  
Option 1

Test Condition	DUT Orientation	Link Angle	Measurement Angle	Diagram
Free space DUT Orientation 1 (default)	$\Psi = 0^\circ$ $\Theta = 0^\circ$ $\Phi = 0^\circ$	$\theta_{Link}; \phi_{Link}$ with polarization reference $Pol_{Link} = \theta$ or $\phi$	$\theta_{Meas}; \phi_{Meas}$ with polarization reference $Pol_{Meas} = \theta$ or $\phi$	
Free space DUT Orientation 2 - Option 1 (based on re-positioning approach)	$\Psi = 180^\circ$ $\Theta = 0^\circ$ $\Phi = 0^\circ$	$\theta_{Link}; \phi_{Link}$ with polarization reference $Pol_{Link} = \theta$ or $\phi$	$\theta_{Meas}; \phi_{Meas}$ with polarization reference $Pol_{Meas} = \theta$ or $\phi$	
Free space DUT Orientation 2 - Option 2 (based on re-positioning approach)	$\Psi = 0^\circ$ $\Theta = 180^\circ$ $\Phi = 0^\circ$	$\theta_{Link}; \phi_{Link}$ with polarization reference $Pol_{Link} = \theta$ or $\phi$	$\theta_{Meas}; \phi_{Meas}$ with polarization reference $Pol_{Meas} = \theta$ or $\phi$	

NOTE 1: A polarization reference, as defined in relation to the reference coordinate system, is maintained for each link and measurement angle  
 NOTE 2: The order of rotation angles listed in the DUT orientation column corresponds to the necessary order of rotations.

Table 4.1-2 Millimeter-Wave DUT Test Conditions and Angle Definitions for Smartphones and Tablets for Alignment  
Option 2

Test Condition	DUT Orientation	Link Angle	Measurement Angle	Diagram
Free space DUT Orientation 1 (default)	$\Psi = 0^\circ$ $\Theta = -90^\circ$ $\Phi = 0^\circ$	$\theta_{Link}; \phi_{Link}$ with polarization reference $Pol_{Link} = \theta$ or $\phi$	$\theta_{Meas}; \phi_{Meas}$ with polarization reference $Pol_{Meas} = \theta$ or $\phi$	
Free space DUT Orientation 2 - Option 1 (based on re-positioning approach)	$\Psi = 180^\circ$ $\Theta = 90^\circ$ $\Phi = 0^\circ$	$\theta_{Link}; \phi_{Link}$ with polarization reference $Pol_{Link} = \theta$ or $\phi$	$\theta_{Meas}; \phi_{Meas}$ with polarization reference $Pol_{Meas} = \theta$ or $\phi$	
Free space DUT Orientation 2 - Option 2 (based on re-positioning approach)	$\Psi = 0^\circ$ $\Theta = 90^\circ$ $\Phi = 0^\circ$	$\theta_{Link}; \phi_{Link}$ with polarization reference $Pol_{Link} = \theta$ or $\phi$	$\theta_{Meas}; \phi_{Meas}$ with polarization reference $Pol_{Meas} = \theta$ or $\phi$	

NOTE 1: A polarization reference, as defined in relation to the reference coordinate system, is maintained for each link and measurement angle  
NOTE 2: The order of rotation angles listed in the DUT orientation column corresponds to the necessary order of rotations.

Table 4.1-3 Millimeter-Wave DUT Test Conditions and Angle Definitions for Smartphones and Tablets for Alignment  
Option 3

Test Condition	DUT Orientation	Link Angle	Measurement Angle	Diagram
Free space DUT Orientation 1 (default)	$\Psi = 90^\circ$ $\Theta = 0^\circ$ $\Phi = 0^\circ$	$\theta_{Link}; \phi_{Link}$ with polarization reference $Pol_{Link} = \theta$ or $\phi$	$\theta_{Meas}; \phi_{Meas}$ with polarization reference $Pol_{Meas} = \theta$ or $\phi$	
Free space DUT Orientation 2 - Option 1 (based on re-positioning approach)	$\Psi = -90^\circ$ $\Theta = 0^\circ$ $\Phi = 0^\circ$	$\theta_{Link}; \phi_{Link}$ with polarization reference $Pol_{Link} = \theta$ or $\phi$	$\theta_{Meas}; \phi_{Meas}$ with polarization reference $Pol_{Meas} = \theta$ or $\phi$	
Free space DUT Orientation 2 - Option 2 (based on re-positioning approach)	$\Psi = 90^\circ$ $\Theta = 180^\circ$ $\Phi = 0^\circ$	$\theta_{Link}; \phi_{Link}$ with polarization reference $Pol_{Link} = \theta$ or $\phi$	$\theta_{Meas}; \phi_{Meas}$ with polarization reference $Pol_{Meas} = \theta$ or $\phi$	

NOTE 1: A polarization reference, as defined in relation to the reference coordinate system, is maintained for each link and measurement angle  
 NOTE 2: The order of rotation angles listed in the DUT orientation column corresponds to the necessary order of rotations.

Table 4.1-4 through Table 4.1-6 below provide the test conditions and angle definitions for the three permitted device alignment options for Fixed Wireless Access (FWA) for the default test condition, DUT orientation 1, and two different options for each permitted device alignment to re-position the device for DUT orientation 2 as outlined in Figures 4.1-2 and 4.1-3. Due to changes in DUT orientations  $\Psi$ ,  $\Theta$ , and  $\Phi$  for the alignment options for FWA proposed in Table 4.1-5 through Table 4.1-6 when compared to those in Tables 4.1-2 through 4.1-3, new alignment options, i.e., Options 4 and 5, were introduced.

Table 4.1-4 Millimeter-Wave DUT Test Conditions and Angle Definitions for FWA for Alignment Option 1

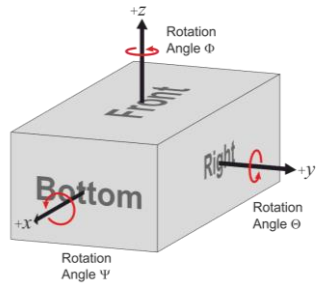
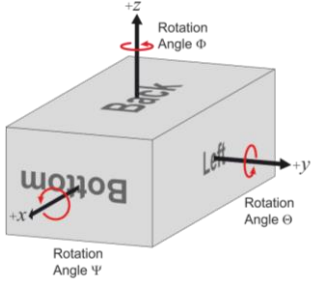
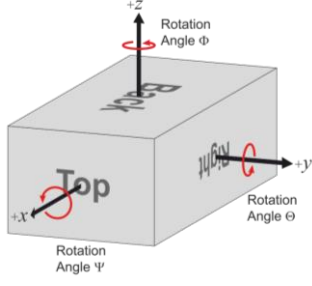
Test condition	DUT orientation	Link angle	Measurement angle	Diagram
Free space DUT Orientation 1 (default)	$\Psi = 0^\circ$ $\Theta = 0^\circ$ $\Phi = 0^\circ$	$\theta_{Link};$ $\phi_{Link}$ with polarization reference $Pol_{Link} = \theta$ or $\phi$	$\theta_{Meas};$ $\phi_{Meas}$ with polarization reference $Pol_{Meas} = \theta$ or $\phi$	
Free space DUT Orientation 2 - Option 1 (based on re-positioning approach)	$\Psi = 180^\circ$ $\Theta = 0^\circ$ $\Phi = 0^\circ$	$\theta_{Link};$ $\phi_{Link}$ with polarization reference $Pol_{Link} = \theta$ or $\phi$	$\theta_{Meas};$ $\phi_{Meas}$ with polarization reference $Pol_{Meas} = \theta$ or $\phi$	
Free space DUT Orientation 2 - Option 2 (based on re-positioning approach)	$\Psi = 0^\circ$ $\Theta = 180^\circ$ $\Phi = 0^\circ$	$\theta_{Link};$ $\phi_{Link}$ with polarization reference $Pol_{Link} = \theta$ or $\phi$	$\theta_{Meas};$ $\phi_{Meas}$ with polarization reference $Pol_{Meas} = \theta$ or $\phi$	

NOTE 1: A polarization reference, as defined in relation to the reference coordinate system, is maintained for each link and measurement angle  
 NOTE 2: The order of rotation angles listed in the DUT orientation column corresponds to the necessary order of rotations.

Table 4.1-5 Millimeter-Wave DUT Test Conditions and Angle Definitions for FWA for Alignment Option 4

Test condition	DUT orientation	Link angle	Measurement angle	Diagram
Free space DUT Orientation 1 (default)	$\Psi = 90^\circ$ $\Theta = 0^\circ$ $\Phi = 90^\circ$	$\theta_{Link}$ ; $\phi_{Link}$ with polarization reference $Pol_{Link} = \theta$ or $\phi$	$\theta_{Meas}$ ; $\phi_{Meas}$ with polarization reference $Pol_{Meas} = \theta$ or $\phi$	
Free space DUT Orientation 2 - Option 1 (based on re-positioning approach)	$\Psi = -90^\circ$ $\Theta = 0^\circ$ $\Phi = -90^\circ$	$\theta_{Link}$ ; $\phi_{Link}$ with polarization reference $Pol_{Link} = \theta$ or $\phi$	$\theta_{Meas}$ ; $\phi_{Meas}$ with polarization reference $Pol_{Meas} = \theta$ or $\phi$	
Free space DUT Orientation 2 - Option 2 (based on re-positioning approach)	$\Psi = -90^\circ$ $\Theta = 0^\circ$ $\Phi = 90^\circ$	$\theta_{Link}$ ; $\phi_{Link}$ with polarization reference $Pol_{Link} = \theta$ or $\phi$	$\theta_{Meas}$ ; $\phi_{Meas}$ with polarization reference $Pol_{Meas} = \theta$ or $\phi$	

NOTE 1: A polarization reference, as defined in relation to the reference coordinate system, is maintained for each link and measurement angle  
 NOTE 2: The order of rotation angles listed in the DUT orientation column corresponds to the necessary order of rotations.



Table 4.1-6 Millimeter-Wave DUT Test Conditions and Angle Definitions for FWA for Alignment Option 5

Test condition	DUT orientation	Link angle	Measurement angle	Diagram
Free space DUT Orientation 1 (default)	$\Psi = 0^\circ$ $\Theta = 90^\circ$ $\Phi = 0^\circ$	$\theta_{Link};$ $\phi_{Link}$ with polarization reference $Pol_{Link} = \theta$ or $\phi$	$\theta_{Meas};$ $\phi_{Meas}$ with polarization reference $Pol_{Meas} = \theta$ or $\phi$	
Free space DUT Orientation 2 - Option 1 (based on re-positioning approach)	$\Psi = 180^\circ$ $\Theta = -90^\circ$ $\Phi = 0^\circ$	$\theta_{Link};$ $\phi_{Link}$ with polarization reference $Pol_{Link} = \theta$ or $\phi$	$\theta_{Meas};$ $\phi_{Meas}$ with polarization reference $Pol_{Meas} = \theta$ or $\phi$	
Free space DUT Orientation 2 - Option 2 (based on re-positioning approach)	$\Psi = 0^\circ$ $\Theta = -90^\circ$ $\Phi = 0^\circ$	$\theta_{Link};$ $\phi_{Link}$ with polarization reference $Pol_{Link} = \theta$ or $\phi$	$\theta_{Meas};$ $\phi_{Meas}$ with polarization reference $Pol_{Meas} = \theta$ or $\phi$	

NOTE 1: A polarization reference, as defined in relation to the reference coordinate system, is maintained for each link and measurement angle  
 NOTE 2: The order of rotation angles listed in the DUT orientation column corresponds to the necessary order of rotations.

Table 4.1-7 below provides the test conditions and angle definitions for the permitted device alignment for laptops for the default test condition, DUT orientation 1, and two different options for each permitted device alignment to re-position the device for DUT orientation 2 as outlined in Table 4.1-8 and Table 4.1-9. The display is open at a lid angle of  $110^\circ \pm 5^\circ$ , where lid angle is defined as the angle between the front of the display to the levelled base, and the full projected volume is centered inside the test volume. Due to changes in DUT orientations  $\Psi$ ,  $\Theta$ , and  $\Phi$  for the laptop alignment option proposed in Table 4.1-8. Table 4.1-8 Millimeter-Wave DUT Test Conditions and Angle Definitions for Laptops for Alignment Option 5

Test condition	DUT orientation	Link angle	Measurement angle	Diagram
Free space DUT Orientation 1 (default)	$\Psi = 0^\circ$ $\Theta = 90^\circ$ $\Phi = 0^\circ$	$\theta_{Link}$ ; $\phi_{Link}$ with polarization reference PolLink = $\theta$ or $\phi$	$\theta_{Meas}$ ; $\phi_{Meas}$ with polarization reference PolMeas = $\theta$ or $\phi$	
Free space DUT Orientation 2 - Option 1 (based on re-positioning approach)	$\Psi = 180^\circ$ $\Theta = -90^\circ$ $\Phi = 0^\circ$	$\theta_{Link}$ ; $\phi_{Link}$ with polarization reference PolLink = $\theta$ or $\phi$	$\theta_{Meas}$ ; $\phi_{Meas}$ with polarization reference PolMeas = $\theta$ or $\phi$	
Free space DUT Orientation 2 - Option 2 (based on re-positioning approach)	$\Psi = 0^\circ$ $\Theta = -90^\circ$ $\Phi = 0^\circ$	$\theta_{Link}$ ; $\phi_{Link}$ with polarization reference PolLink = $\theta$ or $\phi$	$\theta_{Meas}$ ; $\phi_{Meas}$ with polarization reference PolMeas = $\theta$ or $\phi$	

NOTE 1: A polarization reference, as defined in relation to the reference coordinate system, is maintained for each link and measurement angle  
 NOTE 2: The order of rotation angles listed in the DUT orientation column corresponds to the necessary order of rotations.

Table 4.1-9 when compared to those introduced earlier, a new alignment option, i.e., Option 6, was introduced.

Table 4.1-7 Millimeter-Wave DUT Test Conditions and Angle Definitions for Laptops for Alignment Option 1

Test condition	DUT orientation	Link angle	Measurement angle	Diagram
Free space DUT Orientation 1 (default)	$\Psi = 0^\circ$ $\Theta = 0^\circ$ $\Phi = 0^\circ$	$\theta_{Link}$ ; $\phi_{Link}$ with polarization reference $Pol_{Link} = \theta$ or $\phi$	$\theta_{Meas}$ ; $\phi_{Meas}$ with polarization reference $Pol_{Meas} = \theta$ or $\phi$	
Free space DUT Orientation 2 - Option 1 (based on re-positioning approach)	$\Psi = 180^\circ$ $\Theta = 0^\circ$ $\Phi = 0^\circ$	$\theta_{Link}$ ; $\phi_{Link}$ with polarization reference $Pol_{Link} = \theta$ or $\phi$	$\theta_{Meas}$ ; $\phi_{Meas}$ with polarization reference $Pol_{Meas} = \theta$ or $\phi$	
Free space DUT Orientation 2 - Option 2 (based on re-positioning approach)	$\Psi = 0^\circ$ $\Theta = 180^\circ$ $\Phi = 0^\circ$	$\theta_{Link}$ ; $\phi_{Link}$ with polarization reference $Pol_{Link} = \theta$ or $\phi$	$\theta_{Meas}$ ; $\phi_{Meas}$ with polarization reference $Pol_{Meas} = \theta$ or $\phi$	

NOTE 1: A polarization reference, as defined in relation to the reference coordinate system, is maintained for each link and measurement angle  
 NOTE 2: The order of rotation angles listed in the DUT orientation column corresponds to the necessary order of rotations.

Table 4.1-8 Millimeter-Wave DUT Test Conditions and Angle Definitions for Laptops for Alignment Option 5

Test condition	DUT orientation	Link angle	Measurement angle	Diagram
Free space DUT Orientation 1 (default)	$\Psi = 0^\circ$ $\Theta = 90^\circ$ $\Phi = 0^\circ$	$\theta_{Link}$ ; $\phi_{Link}$ with polarization reference $Pol_{Link} = \theta$ or $\phi$	$\theta_{Meas}$ ; $\phi_{Meas}$ with polarization reference $Pol_{Meas} = \theta$ or $\phi$	
Free space DUT Orientation 2 - Option 1 (based on re-positioning approach)	$\Psi = 180^\circ$ $\Theta = -90^\circ$ $\Phi = 0^\circ$	$\theta_{Link}$ ; $\phi_{Link}$ with polarization reference $Pol_{Link} = \theta$ or $\phi$	$\theta_{Meas}$ ; $\phi_{Meas}$ with polarization reference $Pol_{Meas} = \theta$ or $\phi$	
Free space DUT Orientation 2 - Option 2 (based on re-positioning approach)	$\Psi = 0^\circ$ $\Theta = -90^\circ$ $\Phi = 0^\circ$	$\theta_{Link}$ ; $\phi_{Link}$ with polarization reference $Pol_{Link} = \theta$ or $\phi$	$\theta_{Meas}$ ; $\phi_{Meas}$ with polarization reference $Pol_{Meas} = \theta$ or $\phi$	

NOTE 1: A polarization reference, as defined in relation to the reference coordinate system, is maintained for each link and measurement angle  
 NOTE 2: The order of rotation angles listed in the DUT orientation column corresponds to the necessary order of rotations.

Table 4.1-9 Millimeter-Wave DUT Test Conditions and Angle Definitions for Laptops for Alignment Option 6

Test condition	DUT orientation	Link angle	Measurement angle	Diagram
Free space DUT Orientation 1 (default)	$\Psi = -90^\circ$ $\Theta = 0^\circ$ $\Phi = 0^\circ$	$\theta_{Link}$ ; $\phi_{Link}$ with polarization reference $Pol_{Link} = \theta$ or $\phi$	$\theta_{Meas}$ ; $\phi_{Meas}$ with polarization reference $Pol_{Meas} = \theta$ or $\phi$	
Free space DUT Orientation 2 - Option 1 (based on re-positioning approach)	$\Psi = 90^\circ$ $\Theta = 0^\circ$ $\Phi = 0^\circ$	$\theta_{Link}$ ; $\phi_{Link}$ with polarization reference $Pol_{Link} = \theta$ or $\phi$	$\theta_{Meas}$ ; $\phi_{Meas}$ with polarization reference $Pol_{Meas} = \theta$ or $\phi$	
Free space DUT Orientation 2 - Option 2 (based on re-positioning approach)	$\Psi = 90^\circ$ $\Theta = 180^\circ$ $\Phi = 0^\circ$	$\theta_{Link}$ ; $\phi_{Link}$ with polarization reference $Pol_{Link} = \theta$ or $\phi$	$\theta_{Meas}$ ; $\phi_{Meas}$ with polarization reference $Pol_{Meas} = \theta$ or $\phi$	

NOTE 1: A polarization reference, as defined in relation to the reference coordinate system, is maintained for each link and measurement angle  
 NOTE 2: The order of rotation angles listed in the DUT orientation column corresponds to the necessary order of rotations.

For each DUT requirement and test case, each of the parameters in the tables above need to be recorded, such that DUT positioning, DUT beam direction, and angles link and measurement are specified in terms of the fixed system coordinate system.

Due to the non-commutative nature of rotations, the order of rotations is important and needs to be defined when multiple DUT orientations are tested.

The following order of rotations needs to be followed for the device orientations specified in this test plan:  
 $\Psi$  (rotation around the  $x$  axis)  $\rightarrow$   $\Theta$  (rotation around the  $y$  axis)  $\rightarrow$   $\Phi$  (rotation around the  $z$  axis).

The rotations around the  $x$ ,  $y$ , and  $z$  axes can be defined with the following rotation matrices:

$$R_x(\Psi) = \begin{bmatrix} 1 & 0 & 0 & 0 \\ 0 & \cos \Psi & -\sin \Psi & 0 \\ 0 & \sin \Psi & \cos \Psi & 0 \\ 0 & 0 & 0 & 1 \end{bmatrix}$$

$$R_y(\Theta) = \begin{bmatrix} \cos \Theta & 0 & \sin \Theta & 0 \\ 0 & 1 & 0 & 0 \\ -\sin \Theta & 0 & \cos \Theta & 0 \\ 0 & 0 & 0 & 1 \end{bmatrix}$$

and

$$R_z(\Phi) = \begin{bmatrix} \cos \Phi & -\sin \Phi & 0 & 0 \\ \sin \Phi & \cos \Phi & 0 & 0 \\ 0 & 0 & 1 & 0 \\ 0 & 0 & 0 & 1 \end{bmatrix}$$

with the respective angles of rotation  $\Psi$ ,  $\Theta$ , and  $\Phi$  and:

$$\begin{bmatrix} x' \\ y' \\ z' \\ 1 \end{bmatrix} = R \begin{bmatrix} x \\ y \\ z \\ 1 \end{bmatrix}$$

Additionally, any translation of the DUT can be defined with the translation matrix:

$$T(t_x, t_y, t_z) = \begin{bmatrix} 1 & 0 & 0 & t_x \\ 0 & 1 & 0 & t_y \\ 0 & 0 & 1 & t_z \\ 0 & 0 & 0 & 1 \end{bmatrix}$$

with offsets  $t_x$ ,  $t_y$ ,  $t_z$  in  $x$ ,  $y$ , and  $z$ , respectively and with:

$$\begin{bmatrix} x' \\ y' \\ z' \\ 1 \end{bmatrix} = T \begin{bmatrix} x \\ y \\ z \\ 1 \end{bmatrix}$$

The combination of rotations and translation is captured by the multiplication of rotation and translation matrices.

For this test plan, the matrix  $M$  is defined as:

$$M = R_z(\Phi) \cdot R_y(\Theta) \cdot R_x(\Psi)$$

which describes an initial rotation of the DUT around the  $x$  axis with angle  $\Psi$ , a subsequent rotation around the  $y$  axis with angle  $\Theta$ , and a final rotation around the  $z$  axis with angle  $\Phi$ .

The DUT coordinates can then be determined from the measurement/chamber coordinates using the following equation:

$$r_{\text{EUT}} = \begin{bmatrix} x_{\text{EUT}} \\ y_{\text{EUT}} \\ z_{\text{EUT}} \end{bmatrix} = M^{-1} \cdot r_{\text{DUT}} = M^{-1} \cdot \begin{bmatrix} x_{\text{Meas}} \\ y_{\text{Meas}} \\ z_{\text{Meas}} \end{bmatrix} = M^{-1} \cdot \begin{bmatrix} \sin(\theta_{\text{Meas}}) \cos(\phi_{\text{Meas}}) \\ \sin(\theta_{\text{Meas}}) \sin(\phi_{\text{Meas}}) \\ \cos(\theta_{\text{Meas}}) \end{bmatrix}$$

with

$$\theta_{\text{EUT}} = \text{acos}(z_{\text{EUT}}) \text{ and}$$

$$\phi_{\text{EUT}} = \text{atan}(y_{\text{EUT}}/x_{\text{EUT}})$$

Near-field coupling effects between the antenna and the pedestals/positioners/fixtures generally cause increased signal ripples. Re-positioning the DUT in order to direct the beam peak away from those areas can reduce the effect of signal ripple on EIRP/EIS measurements. The figures below illustrate how the DUT is repositioned within the distributed axes and combined axes system, when:

- The beam peak is directed to the DUTs upper hemisphere (DUT orientation 1) or
- The beam peak is directed to the DUTs lower hemisphere (DUT orientation 2).

While these figures are examples of different positioning systems and other implementations are not precluded, the relative orientation of the coordinate system with respect to the antennas/reflectors and the axes of rotation shall apply to any measurement setup.

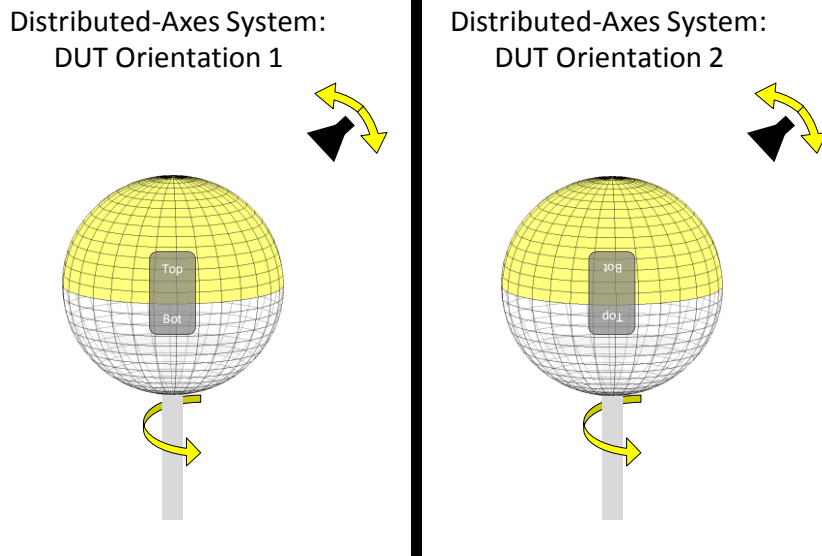

Figure 4.1-2 Millimeter-Wave DUT Re-Positioning for an Example of Distributed-Axes System

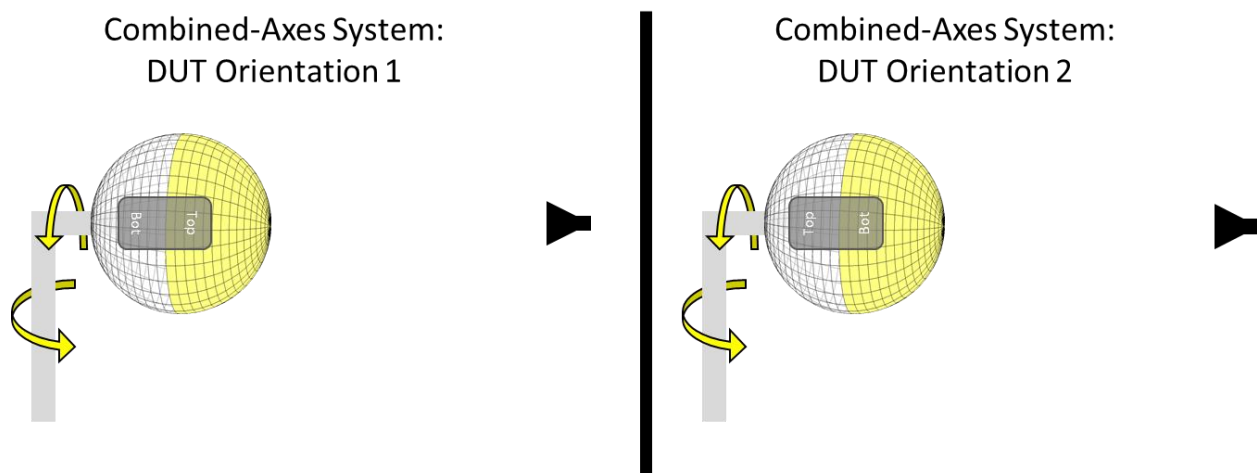

Figure 4.1-3 DUT Re-Positioning for an Example of Combined-Axes System

For EIRP/EIS measurements, it is important to re-position the DUT to ensure the pedestal is not obstructing the beam path and to ensure that the pedestal is not in closer proximity to the measurement antenna/reflector than the DUT. For TRP measurements, re-positioning the DUT ensures that the beam peak direction is not obstructed by the pedestal and the pedestal is in the measurement path only when measuring the DUT' back-hemisphere. No re-positioning of the DUT during the TRP measurement is required.

The radiating portions of the device shall be fully enclosed within the quiet zone, but the non-radiating portions of the device can be located/placed outside the quiet zone if a vendor declaration with positioning reference points and the minimum QZ required to contain all active antennas within the quiet zone (per band) is provided. This gray-box testing approach where the declared reference point is aligned with the center of the QZ is further illustrated in [Figure 4.1 4](#).



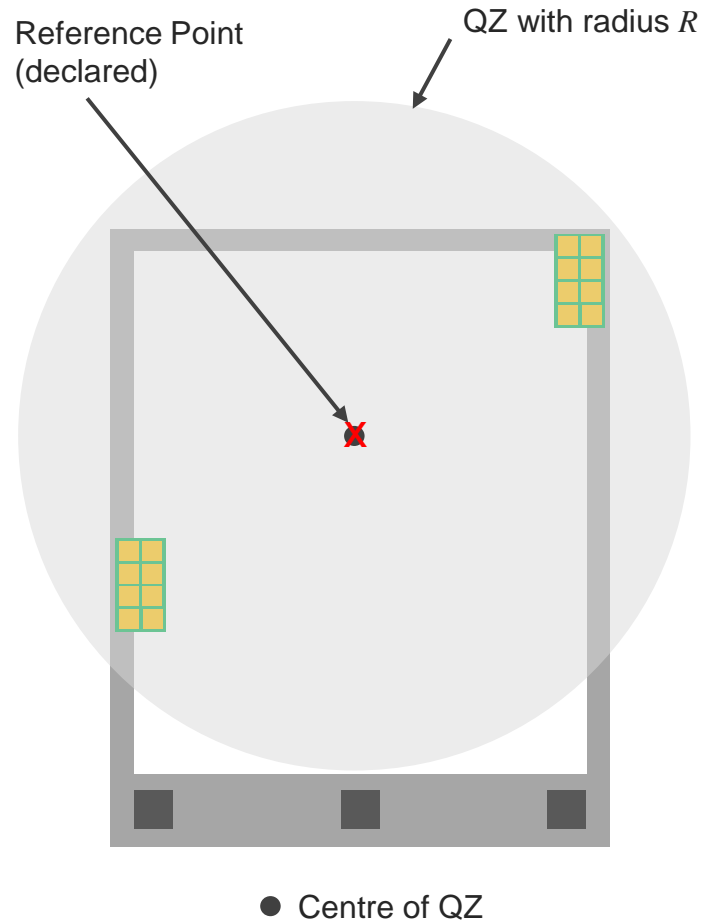
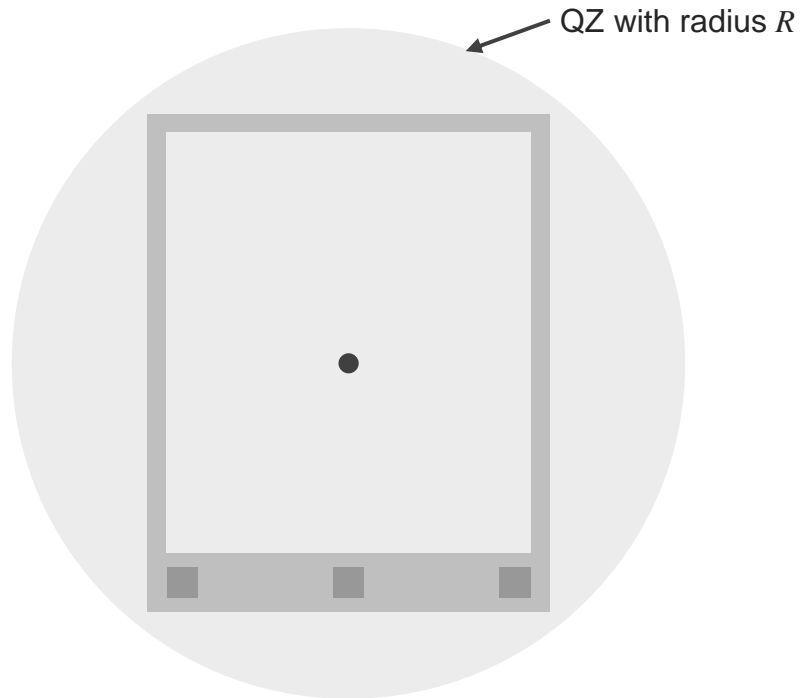

Figure 4.1 4: Gray-Box Test Approach

In the absence of a vendor declaration, the geometric center of the DUT shall be aligned with the center of the QZ and the DUT shall be fully contained within the QZ. This black-box testing approach is further illustrated in [Figure 4.1 5](#).



- Centre of QZ (aligned with geometric centre of DUT)

Figure 4.1 5: Black-Box Test Approach

## Section 5 SISO, Reverberation Chamber Test Setup Configurations

### 5.1 DUT and Reference Antenna Location within the Test Volume

The reverberation chamber test volume is defined in Section 1.1.1 of *CTIA 01.21* [6]. It includes these characteristics:

- The valid test volume is the volume for which uncertainties have been established per *CTIA 01.73* [2] Section 6.2.3.
- The valid test volume shall satisfy the Proximity Effect Test (*CTIA 01.73* [2] Section 6.2.2), and in other regards is suitable to hold a device under test or device under test plus phantom, if utilized. The Uncertainty due to Lack of Spatial Uniformity (in *CTIA 01.73* [2] Section 6.2.3) and Reference Power Transfer Function (*CTIA 01.21* [6] Section 2.1) shall be determined in the test volume with the phantom in the chamber in the position where it will be located during a DUT TIS/TRP measurement.

Valid test volume boundaries shall be located at least 0.5 wavelength at the frequency of operation from the walls, mechanical mode-stirrers (if used), and the antennas. Floor-standing devices may be placed closer than 0.5 wavelength to the floor of the reverberation chamber as long as the radiating element is farther than 0.5 wavelength from the floor.

For chamber precharacterization, reference and DUT measurements, per Section 1.1.1 of *CTIA 01.21* [6], the test volume shall encompass both the reference antenna and the DUT. The separation between the reference antenna and the DUT shall exceed the minimum distance determined by the Proximity Effect evaluation specified in *CTIA 01.73* [2] Section 6.2.2.

For reference measurements, per Section 2.1 of *CTIA 01.21* [6], the reference antenna shall be placed in the test volume of the chamber in such a way that it undergoes the same stirring sequence as the DUT antenna during the TRP or TIS measurements. Directional reference antennas shall be pointed away from both the DUT and the measurement antennas.

For DUT measurements, per Section 2.2 and 2.3 of *CTIA 01.21* [6], the free-space DUT or DUT mounted on a phantom shall be positioned within the test volume of the chamber so that the chamber loading is the same for the reference power transfer function characterization and DUT measurement steps and so that it undergoes the same stirring sequence as the reference antenna during the calibration and characterization tests.

### 5.2 DUT Free Space Positioning Requirements

The chassis and radiating element(s) of the DUT shall be positioned within the test volume in any location or orientation meeting the criteria in Section 5.1 above. Note that stepped position stirring of the DUT itself (i.e., a change in the orientation of the DUT with respect to the Measurement antenna) is allowed within the test volume, as long as the Reference antenna undergoes the same stirring sequence.

### 5.3 DUT Positioning Requirements on Phantoms

The DUT shall be positioned on the phantom per the applicable subsections in Section 2. ([Section 2.3 Positioning Requirements Wrist-Worn Device](#); [Section 2.4 Positioning Guidelines for Chest-Worn Devices](#); [Section 2.5 Positioning Guidelines for Ankle-Worn Devices](#)). Applicable sections relate to the required orientation of the DUT on the phantom, as opposed to sections that describe the required orientation of the DUT within the chamber. For example, when testing a wrist-worn DUT, the configuration in Section 2.3.2 “Mounting a Wrist-Worn DUT on the Forearm Phantom” of this document shall be followed. However, there is no requirement that the phantom be placed according to a specific Chamber Coordinate System, as discussed in Section 2.3.1.

The DUT mounted on the phantom shall be positioned within the test volume in any location or orientation meeting the criteria in Section 5.1. Note that stepped position stirring of the DUT plus phantom (i.e., a change in the orientation of the DUT plus phantom with respect to the Measurement antenna) is allowed within the test volume, as long as the Reference antenna undergoes the same stirring sequence.

## Appendix A Revision History

Date	Version	Description
February 2022	4.0.0	Initial release Section 2: <ul style="list-style-type: none"> <li>• Contents moved from SISO OTA test plan (Sections A.1, Q.6, L.4, L.8 and L.9)</li> <li>• Addition of positioning guidelines for chest-worn devices.</li> </ul> Section 3: <ul style="list-style-type: none"> <li>• Contents moved from MIMO OTA test plan (Section 2.3, Appendix D and Appendix E).</li> <li>• Addition of DUT positioning within the RTS Test Volume.</li> </ul> Section 4: <ul style="list-style-type: none"> <li>• Contents moved from mm-wave OTA test plan (Appendix A)</li> </ul>
November 2022	4.0.1	<b>Section 5:</b> <ul style="list-style-type: none"> <li>• Added clarifications for test setup configurations.</li> </ul>
December 2022	5.0.0	<b>Section 2:</b> <ul style="list-style-type: none"> <li>• Added Section 2.5, Positioning Guidelines for Ankle-Worn Devices</li> </ul>
March 2023	6.0.0	<b>Section 4:</b> <ul style="list-style-type: none"> <li>• Added positioning guidelines for Fixed Wireless Access (FWA) devices and laptops</li> <li>• Added the gray-box testing approach</li> </ul>
April 2024	7.0.0	<b>Section 2:</b> <ul style="list-style-type: none"> <li>• Positioning guidelines for chest-worn devices was changed to Normative</li> <li>• Added missing device setup guidelines to Section 2.3, Section 2.4, and Section 2.5</li> <li>• Added test configurations based on manufacturer-approved carry accessory</li> </ul> <b>Section 5:</b> <ul style="list-style-type: none"> <li>• Added positioning guidelines for phantoms used in the Reverberation Chamber in Section 5.1, and Section 5.3</li> </ul>