



Authorized Service Provider Certification Program

Version 1.0

October 2019

© 2019 CTIA®. All Rights Reserved.

Any reproduction or transmission of all or part of this publication, in any form, or by any means, whether electronic or mechanical, including photocopying, recording, or via any information storage and retrieval system, without the prior written permission of CTIA, is unauthorized and strictly prohibited by federal copyright law. Similarly, any modification or alteration of this publication, including without limitation, the removal of any CTIA-owned name, logo, or copyright language, or the affixation of any other entity name, logo, or copyright language to the publication, is unauthorized and strictly prohibited.

Any unauthorized use of this publication by any organization, including without limitation CTIA member companies, is strictly prohibited unless authorized by CTIA or its assigns in writing.

Any reproduction of this publication, as authorized herein, shall contain the above notice in substantially the same language and form and "© 2019 CTIA®. All Rights Reserved." on all subsequent pages.

WISE Certification Program

1400 16th Street, NW

Suite 600

Washington, DC 20036

programs@wisecertification.com

www.wisecertification.com

Acknowledgements

This document was created by the wireless industry with input from the following companies and their representatives:

AGiRepair	Injured Gadgets
Allstate/iCracked	iQmetrix
Apkudo	LG Electronics
Apple	Luna Systems
Assurant	Motorola
Asurion	Remade Group
B-Stock Solutions	Samsung
Batteries Plus Bulbs	ServiceCentral Technologies
Comcast – Xfinity Mobile	Sprint
Custom Communications	Werx Repair Services
Google	U.S. Cellular
iFixYouri	uBreakiFix
	United Smart Tech

Table of Contents

Section 1	Introduction	7
1.1	Purpose	7
1.2	Scope	7
1.3	Acronyms and Terms	7
1.4	References	8
Section 2	Qualifications	9
2.1	Retail Environment	9
2.1.1	Standalone Brick and Mortar Retail Store	9
2.1.2	Store-within-a-Store	9
2.1.3	Business Park	10
2.1.4	Environments Not Eligible	10
2.2	Remote Technician Organization	10
Section 3	Requirements	11
3.1	Certified Technicians	11
3.1.1	Definitions	11
3.1.2	Staffing Requirements	12
3.2	Website and Online Presence	12
3.3	Retail Environment Exterior	12
3.4	Retail Environment Interior	13
3.5	Remote Technician Organization Vehicles	13
3.6	Remote Technician Organization Clothing & Badges	13
3.7	Tools	13
3.8	Customer Experience	14
3.8.1	Retail Environment	14
3.8.2	Remote Technician Organization	14
3.9	Identifying Warranty/Coverage Options	15
3.9.1	Original Equipment Manufacturer (OEM) Warranty	15
3.9.2	Extended Warranty	15
3.9.3	Service Center Warranty	16
3.9.4	Third-Party Insurance	16
3.10	Repair Terms and Conditions	17
3.10.1	Limited Liability & Warranty	18
3.10.2	Limitations on Damages	18
3.10.3	Liquid Damage Policy	18
3.10.4	Device Abandonment Policy	18
3.10.5	Software Acknowledgement	18
3.11	Privacy Policy	19
3.11.1	Customer Information	19
3.11.2	Customer Personal Information	19
3.11.3	Customer Data Privacy	19
3.12	Lost and Stolen Devices	20
3.13	Diagnosis and Triage Process	20
3.14	Safety, Security & Storage	20

3.14.1	Handling of Lithium Ion (Li-Ion) Batteries	21
3.14.2	Employee Emergency Action Plan	21
3.14.3	First Aid Procedures	21
3.15	Point of Sale Minimum Requirements	21
3.16	Reporting Minimum Requirements	22
3.17	Inventory Management Requirements	22
3.18	Management and Employee Review	22
3.19	Ongoing Training Commitment.....	22
3.20	Risk of Loss.....	22
Section 4	Authorization Process.....	23
4.1	Application Submission	23
4.2	Application Review	23
4.3	Application Acceptance	23
4.4	License and Service Agreement	23
4.5	License Fee	23
4.6	Authorization.....	23
Section 5	Ongoing Compliance Requirements	24
5.1	Notification of Material Financial or Management Changes	24
5.2	License and Service Agreement Renewal.....	24
5.3	License Renewal Fee.....	24
Appendix A	Required Tools.....	25
Appendix B	Sample Diagnosis and Triage Process	31
B.1	Pre-Diagnosis.....	31
B.2	Common Repairs	32
B.3	Upon Receipt of Device	33
B.4	Pre-Test Documentation	34
B.5	Checking Functionality	35
B.6	No Fault Found (NFF) and No Trouble Found (NTF).....	40
B.7	Post-Repair Functional Test.....	41
B.8	Post-Repair Documentation	41
Appendix C	Guidance for Handling Lithium Ion Batteries	42
C.1	Background.....	42
C.2	Battery Service: Recommended Equipment.....	42
C.3	Battery Service: Safety Precautions, Training, and Handling Guidelines	43
C.4	Battery Safety Training	43
C.4.1	Key Handling and Safety Points	43
C.4.2	Guidance on New Battery Assembly.....	44
C.4.3	Storage Guidelines	44

C.4.4 Battery Recycling and Shipment 45

C.4.5 Remote Technicians and Thermal Events 45

Appendix D Revision History 46

Section 1 Introduction

1.1 Purpose

This document defines the Wireless Industry Service Excellence (WISE™) certification program for customer-facing service providers conducting repairs on wireless devices. The WISE Authorized Service Provider (ASP) designation conveys service excellence. It allows service providers to differentiate themselves, demonstrating their commitment to quality by meeting the high levels of industry standards defined in this program.

Subject to the terms and conditions of the WISE ASP license and service agreement, ASPs may use the WISE logo on storefronts, clothing, vehicles to promote their certification. Certified WISE ASPs may also be identified in an online directory maintained at wisecertification.com.

1.2 Scope

The WISE ASP certification program is available to:

- Retail environments performing customer-facing repairs on wireless devices
- Remote technicians deployed to perform onsite repairs on wireless devices

WISE Certification is specific to the environment. Retail stores are certified individually. Remote technician organizations are certified as an organizational entity.

At the present time, the WISE Certification program is solely focused on repairs of smartphones.

WISE Certification is a standalone, independent certification program administered by CTIA Certification, the wireless industry. The program includes both an Authorized Service Provider program and a Technician Certification program. The authorization is not synonymous with any additional authorizations that may be administered by other organizations including OEMs and carriers. A service provider may hold multiple authorizations; however, WISE Certification does not supersede any other authorizations. A service provider that has obtained WISE Certification shall not represent and advertise itself as having any additional authorizations for which it does not hold.

For more information on the WISE Certified Technician certification program, please visit www.wisecertification.com.

1.3 Acronyms and Terms

Acronym/Term	Definition
ADH	Accidental Damage from Handling
ASP	Authorized Service Provider
CPI	Customer Personal Information
ERP	Enterprise Resource Planning
ESN	Electronic Serial Number
ESD	Electrostatic Discharge
FOH	Front of House

Acronym/Term	Definition
GPS	Global Positioning System
IMEI	International Mobile Equipment Identifier
Level 1 WISE Certified Technician	A technician that is WISE Certified and qualified to repair or resolve issues without opening the device
Level 2 WISE Certified Technician	A technician that is WISE Certified and qualified to repair a device by opening and replacing plug-and-play components
LDI	Liquid Damage Inspection
Li-Ion	Lithium Ion
NFF	No Fault Found
NTF	No Trouble Found
OEM	Original Equipment Manufacturer
PCBA	Printed Circuit Board Assembly
PCI	Payment Card Industry
R2	Responsible Recycling
Remote Technician Organization	An organization providing a resolution at a customer's home or place of the customer's choosing
Retail Environment	A brick and mortar location that is customer-facing
WISE	Wireless Industry Service Excellence

1.4 References

- [1] CTIA Wireless Device Grading Scales Criteria and Definitions, <https://www.ctia.org/about-ctia/programs/certification-resources>
- [2] R2: Responsible Recycling Standard for Electronics Recyclers, Sustainable Electronics Recycling International (SERI), 2013 version or later
- [3] IATA: 2019 Lithium Battery Guidance Document, Revision 1 or later

Section 2 Qualifications

2.1 Retail Environment

A Retail Environment is defined as a location where customer-facing service transactions are conducted in a physical retail establishment. In this scenario, the customer is traveling to a destination for a resolution.

To qualify for WISE Certification, a retail service provider shall have a minimum of one year experience in consumer electronics repair or installation. Certification authorization is specific to each retail location. Each individual retail locations do not need to meet the one-year requirement as long as the organization as a whole has met this requirement. The most common Retail Environments eligible for this program are described below.

2.1.1 Standalone Brick and Mortar Retail Store

A standalone brick and mortar retail store environment is defined as a location where the primary service offered is device repair.

2.1.2 Store-within-a-Store

A store-within-a-store environment is defined as a location where device repair is offered as a complimentary service in a dedicated area within a retail partner location.

For store-within-a-store environments, it is understood that these repair locations do not always control the store layout of their retail partner, nor its storefront presentation. The following store-within-a-store models are eligible:

- National and regional corporate-owned carrier locations
- National and regional corporate-owned retailer locations, with 30% or more retail space dedicated to consumer electronics

All other store-within-a-store models may require additional auditing prior to approval. These store-within-a-store models include, but not limited to, the following examples:

- Independent carrier locations
- Independent consumer electronics retailers
- In-line mall locations
- Hardware stores
- Bookstores
- Video game stores
- Campus stores
- Base Exchange Store
- Airports
- Auto service centers
- Grocery stores

2.1.3 Business Park

A business park environment is defined as a location where the retail services are conducted in a business park or dedicated and permanent office space clearly listed as a business on a marquee or building directory.

2.1.4 Environments Not Eligible

Kiosks and carts, for example those typically located in shopping malls and public markets, are not eligible for the WISE Certification program.

2.2 Remote Technician Organization

A Remote Technician Organization is defined as an organization providing a resolution at a customer's home or place of the customer's choosing at a location where a repair can be safely completed. In this scenario, the technician is traveling to the customer for a resolution.

To qualify for WISE Certification, the organization's primary scope of work shall be focused around wireless device or consumer electronics repair or installation, with a minimum of one year experience. Certification applies to the organization as an organizational entity.

Organizations may be local, regional, national or international.

Section 3 Requirements

3.1 Certified Technicians

WISE Certification for technicians is described and can be obtained at www.wisecertification.com.

3.1.1 Definitions

3.1.1.1 Level 1 WISE Certified Technician

A Level 1 WISE Certified Technician is a technician that has passed the WISE Certification Knowledge Exam and is considered qualified to repair or resolve issues without opening the device. Capabilities of the Level 1 technician include:

- Basic functionality inspection/test including, at a minimum: digitizer, brightness, mic, speaker, battery, charging port, (cellular, Wi-Fi®, *Bluetooth*® technology)
- Diagnostic testing, that at a minimum includes onboard OEM diagnostic tools and tests capable of testing the battery, storage/memory, and operating system of the device
- Checking for viruses and malware
- Hard reset of device via hardware exterior buttons
- Forced reboot of device via hard or soft function
- Updating of device software (may be needed to resolve issues)
- Familiarity with device data backup and restore options
- Clear/clean a port or headphone jack without opening the device
- Determine if NTF, NFF or user error
- Unlocking a device
- External assessment of liquid damage

3.1.1.2 Level 2 WISE Certified Technician

A Level 2 WISE Certified Technician is a technician that has completed the practical hands-on training and is considered qualified to repair a device by opening and replacing plug-and-play components. Capabilities of the Level 2 technician include:

- Use and or read a multimeter
- Reconnect or reseat cables or component connectors
- Replace exterior button, switch, or single key
- Replace data cable, display cable, or other component cables
- Replace headphone jack or other non-solder, plug-in component
- Replace Wi-Fi/GPS/cellular/*Bluetooth* component cable or component that controls and enables wireless access
- Replace camera(s) without replacing additional parts
- Repair/replace microphone without soldering
- Repair/replace speaker involving non-solder internal speakers or sound components
- Replace daughterboard or secondary board that helps the motherboard control the device
- Replace fan, heatsink or other thermal components
- Remove and replace full-assembly display without a malfunction of additional components on full-assembly display
- Replace display only, while all other components and parts are reused
- Replace front glass digitizer only, while all other components and parts are reused

- Replace full-assembly display
- Replace back, front, bottom, and top case
- Replace battery adhered or installed using screws or other non-solder components
- Replace or repair internal memory cards or components
- Replace non-solder, plug-in charging port component
- Repair non-solder motherboard

3.1.2 Staffing Requirements

3.1.2.1 Retail Environment

A certified Retail Environment shall have a minimum of one Level 2 WISE Certified Technician onsite during posted hours of operation.

3.1.2.2 Remote Technician Organization

All technicians of a certified Remote Technician Organization shall be Level 2 WISE Certified Technicians. New hires have 60 days to complete Level 1 and Level 2 WISE certification.

3.2 Website and Online Presence

The service provider shall have a verified website address. The website shall include:

- Hours of operation
- Addresses, all locations listed
- Phone number(s)
- Contact form
- Email address
- Terms and conditions for customer service
- Scheduling functionality (required for Remote Technician Organizations)
- Pictures of vehicles and technicians (required for Remote Technician Organizations)

All social media sites, as well as search engine listing, shall be up-to-date with hours of operation, addresses/operating locations and phone number(s). Postings shall be business-related and shall not contain personal content.

All content shall be relative to the company's business, factual and not misleading.

Any responses to a negative review shall be professional and not combative.

All inquiries to the website or social media page shall be responded to within 3 hours if received before 3 PM local time, or by 10 AM the following morning if received after 3 PM.

3.3 Retail Environment Exterior

The location shall be visible from the street or within the parking lot of the property in which the retail environment is located.

Signage shall match the exact name of the current business.

Address and hours of operation shall be clearly posted on the exterior. A contact method for afterhours shall also be clearly posted.

Walkways and dedicated parking lots shall be clear of debris. During inclement weather, proper treatment procedures shall be performed.

3.4 Retail Environment Interior

The overall environment shall be clean of debris, food and drink, overstock inventory, and repair equipment and tools.

Merchandising walls shall be organized and shall maintain a professional appearance.

The check-in and check-out counter shall be a dedicated area for customer interaction and transaction, and shall not be used for repair. The counter shall be recognizable and defined, and no less than 40 inches in height.

Repairs being conducted in the front of house shall be at a service desk that is recommended to be a minimum of 48" height x 30" length.

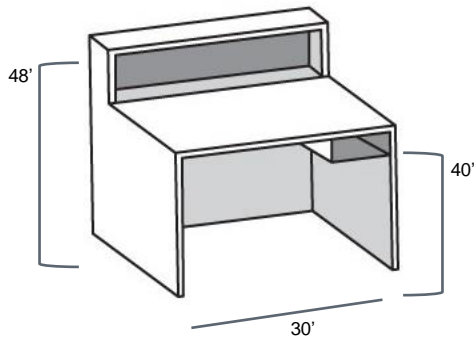

3.5 Remote Technician Organization Vehicles

Vehicles used by technicians shall be:

- Less than 10 years' old
- Branded on the exterior
- Clean
- Free of unrelated stickers or decals
- Free of oil or other fluid leaks

Technicians shall avoid parking in driveways when possible, shall never park on grass or in a yard or garden, and shall not block any other vehicles when possible.

3.6 Remote Technician Organization Clothing & Badges

Technicians shall wear branded clothing.

Technicians shall wear a badge incorporating a photo matching the technician's current appearance, individual name, and company name. The badge shall always be visible on his or her person.

3.7 Tools

There is a wide variety of tools available to retail service providers performing wireless device repairs. Required tools are shown in [Appendix A](#). The retail service provider shall have a defined toolset and processes for:

- Removing screws during disassembly, and a method for maintaining the proper identification for re-assembly
- Removing components that are secured using adhesives. This could include one or multiple of:
 - The proper application of heat
 - The proper application of adhesive solvent
 - The proper application of force to separate components
- Removal of components and sub-assemblies, including connections (i.e., flex cables)
- Preventing electrostatic discharge (ESD) from the technician to a device
- Preventing property damage in the event of a battery thermal event
- Proper device re-assembly, including mechanical screws, snap connectors, and adhesive application
- Accessing and installing the proper software on the device, as required based on the repair type

3.8 Customer Experience

3.8.1 Retail Environment

The location shall remain open during the posted hours of operation.

Customers shall be greeted upon entrance.

Customers shall be asked what is wrong with their device and how the problem(s) may have happened.

The model of the device shall be verified as many customers don't know or believe it is something else.

The customer shall be asked if their device is under warranty or currently has insurance.

The customer shall be given a possible range of fees that may apply to the repair.

The customer shall be given a timeframe of when the full pre-repair triage process will be completed, and when a more accurate repair fee amount will be known.

The customer shall be asked if their data has been backed up and advised of the risk of data loss if not backed up.

3.8.2 Remote Technician Organization

The customer shall be provided the opportunity to complete a scheduling form online in order to prepare the technician for the repair.

The customer shall receive an email confirming appointment date and time along with general instructions on how to back up their device, update to the latest software and be prepared for when the technician arrives.

The technician shall be on time to all appointments, shall call the customer 30 minutes prior to service time window and keep the customer updated on arrival time. The technician may be required to call additional numbers or to reach out to their organization's support staff for assistance in contacting the customer.

The technician shall be professional and respectful in all interactions with the customer.

The technician shall refer the customer to the company's customer service if unable to answer a question.

The repair space shall be a clean environment with appropriate ESD safety executed and electrical outlets (what to do in case of uncontrolled environment).

Repairs shall be completed in the presence of an adult at least 18 years of age.

The technician shall not take the customer's device outside or anywhere beyond the customer's view unless authorized in writing (e.g., terms and conditions agreement, separate consent form).

The technician shall not use the customer's restroom; eat, drink, or smoke in the customer's home, property or place of employment. Also, must not accept food, drink, money, or any other items from the customer.

The technician's priority shall be making sure the customer has a great experience.

The technician shall clean the area when work is completed and take trash upon departure.

The customer shall acknowledge completed repair by signing a post release. This may be signed physically or digitally.

If the device is damaged by the technician, the customer shall be fully refunded or the device replaced.

3.9 Identifying Warranty and Coverage Options

When a customer seeks service for repair, the technician should first determine if the device is covered under one or multiple options outlined below. There are several types of warranties each with their own defined requirements. [Figure 1](#) shows a logical process flow.

A limited warranty covers specified parts, certain types of defects, or other conditions as indicated by the issuing company in the terms of service. It is a good practice to update the customer on their warranty coverage and give them the option to opt-out.

3.9.1 Original Equipment Manufacturer (OEM) Warranty

A warranty provided by the manufacturer typically covers the product against manufacture defects and hardware malfunction. Each OEM's warranty terms and coverage may differ. Technicians shall refer to the OEM's website for details. Items that are not typically covered under manufacture warranty include, but may not be limited to:

- Liquid damage
- Customer abuse such as broken displays or damaged cosmetics typically caused by dropping the device

OEMs reserve the right to change warranty policies at any time.

3.9.2 Extended Warranty

An extended warranty is typically offered to a customer at time of purchase in addition to the standard warranty with broader coverage and timeframe. The extended warranty is offered by a warranty

administrator, the retailer or the manufacturer. There is typically a cost to the customer to purchase an extended warranty which is paid at time of purchasing a new device or billed monthly.

3.9.3 Service Center Warranty

A service center warranty is offered to a customer at the time of repair. Typically, the service center will require the customer to return to the location or a specific provider that performed the work in order to honor the warranty.

3.9.4 Third-Party Insurance

Third-party insurance is typically offered to a customer at time of purchase in addition to the standard warranty and may or may not cover the device depending on the policy chosen. An insurance policy typically covers a lost, stolen or accidentally damaged device. These policies often include liquid and physical damage. There is typically a cost to the customer which is paid at time of purchasing a new device or billed monthly.

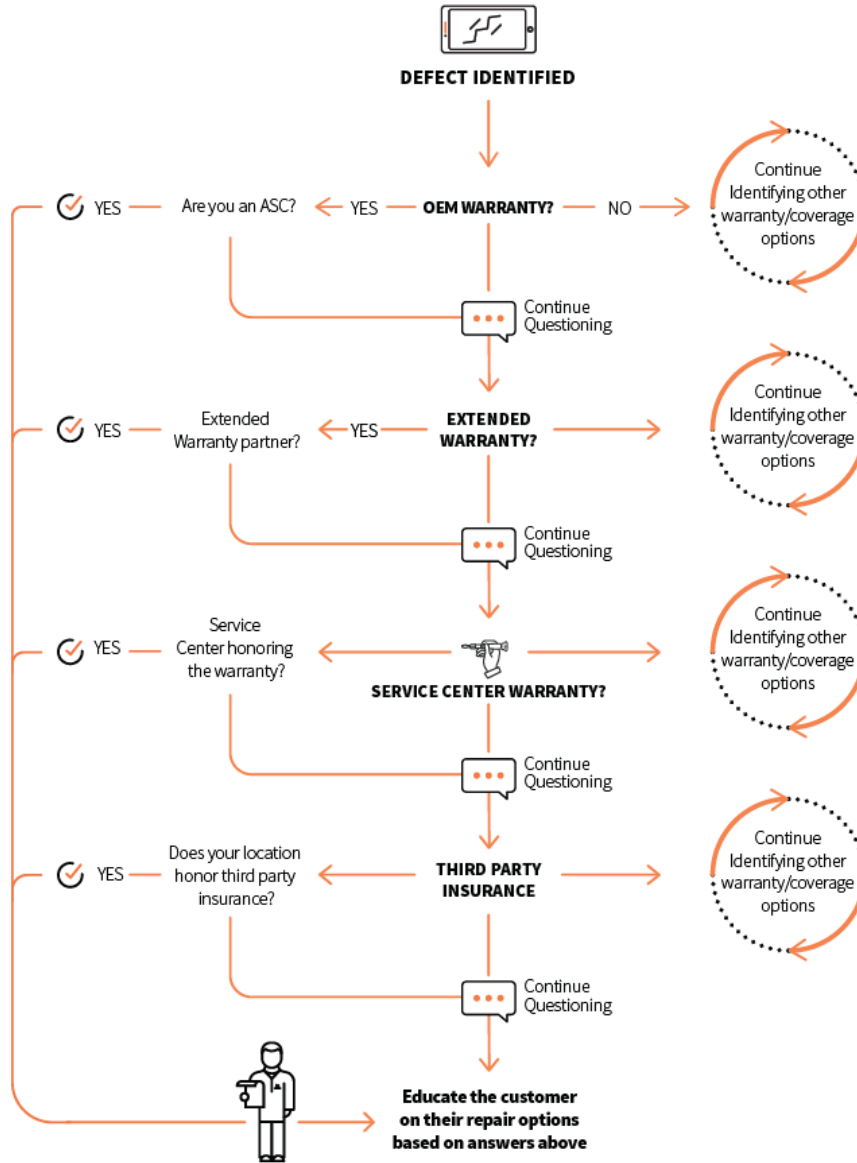

FIGURE 1: IDENTIFYING WARRANTY AND COVERAGE OPTIONS

3.10 Repair Terms and Conditions

The service provider shall have a terms and conditions agreement. Prior to performing a repair, the technician shall review the terms and conditions with the customer and require an acknowledgement with signature. It is recommended that a retailer's terms and conditions agreement include the following policies listed below.

3.10.1 Limited Liability and Warranty

A limited warranty is limited to specified parts, certain types of defects, or other conditions as indicated by the company in their terms of service. It is a good practice to update the customer regarding their warranty coverage and offer the option to opt-out.

3.10.2 Limitations on Damages

The service provider shall have terms covering contractual limitations on damages whereby the business disclaims all other warranties, express or implied, except for any express warranties granted in writing by the business servicing the repair. The purpose of these terms is to make clear that the technician is excluded from being held liable by the customer for any incidental damages.

The service provider should preclude devices that have been previously repaired for issues from warranty coverage unless expressly stated otherwise in a purchased warranty plan. An organization shall also clearly indicate the technician is not responsible for the pre-existing damage, internal or external, of a device that has suffered from Accidental Damage from Handling (ADH). There are many unknown variables to working with a device that has suffered ADH, such as compression damage, loose components, and structural damage. Should the cause for device functionality issues impact damage, the technician should not be held liable for any damage that occurs outside of the terms of the repair. Once the service provider has completed a repair, the service provider should not be responsible for any device defects or functionality issues such as, but not limited to, accidental damage from handling, software defects, overheating, power failure, carrier service, GPS failure.

3.10.3 Liquid Damage Policy

The service provider should have a documented liquid damage policy. The term “liquid damage” includes but is not limited to water, soda, alcohol, sweat and humidity. Any damage incurred to any device by any amount of liquid can be widespread and often unpredictable. Not all liquid damaged devices can be repaired and the device may not be in the same condition after the attempted recovery due to the corrosive nature of liquids. In no event shall a technician be liable for data loss or a device becoming unresponsive due to liquid damage.

3.10.4 Device Abandonment Policy

A Retail Environment shall have a documented Device Abandonment Policy that specifies any device or accessory left after a set period of time as specified by the business should be considered “abandoned” and should be disposed of accordingly. A company’s Device Abandonment Policy shall be in accordance with state laws.

A Retail Environment should set a standard regarding the minimum number of attempts a technician shall make to contact the customer via the contact information regarding the abandoned device. Technicians should not be held responsible for any devices, or the data on those devices that have been abandoned by the customer. It is a good practice to recycle and properly remove all data on an abandoned device.

3.10.5 Software Acknowledgement

When providing a service or repair that requires the installation of diagnostic software or any other necessary software to perform the required service, the service provider shall obtain customer approval. Non-authorized software should never be used during the repair process.

3.11 Privacy Policy

To help ensure the customer's information is secure, service providers shall have established and implemented privacy policies, programs and procedures in accordance with state and federal laws. As a best practice, technicians should only require passwords for testing purposes and should restrict access to personal information to agents who require it to operate, develop, or improve the agreed-upon repair services. Privacy policies should be communicated or shared with the customer in advance of the repair services. The customer shall be responsible for backing up their own device prior to repair.

3.11.1 Customer Information

Customer information shall not be disclosed to any third parties without the customer's consent except to initiate, render, bill and collect for services provided by the repair provider. A technician should reference their organization's Privacy Policy and any customer information policies when determining whether or not the information can be shared with a third party.

3.11.2 Customer Personal Information

Customer Personal Information (CPI) includes the following:

- Customer phone number
- Customer contact information
- Call logs
- Personal contact list
- Phone book
- Pictures/videos
- Dictated notes
- Customer installed applications
- Text messages
- Browsing history
- SIM card
- SD card

The technician shall utilize, or engage a third party who shall utilize, one or more methods in compliance with R2 Data Destruction methodology and NIST 800-88 to clear a device, including any devices or other media used for backup storage, or otherwise render the content unavailable. The 2013 version, or a later version of R2, shall be used.

If necessary and otherwise authorized, the technician shall destroy, or engage a third party to destroy media-bearing devices in compliance with NIST 800-88 in such a manner that the information contained is unrecoverable.

3.11.3 Customer Data Privacy

It is highly likely that technicians will conduct repairs on devices that still contain customer content. For the purposes of this document, content includes, but is not limited to, text messages, photographs, videos, files, call logs, and browsing history. In order to ensure customer content is treated with the utmost sensitivity, service providers shall have and enforce a zero tolerance policy for use of CPI in a manner that violates the requirements of this certification to ensure customer content is treated with the utmost sensitivity.

Access to customer content by a technician shall only be for purposes of validating a claimed defect, or confirming that a repair was successful. In the event of an abandoned device, and prior

to transferring a device to another party, the technician shall utilize, or engage a third party who shall utilize, one or more methods in compliance with R2 Data Destruction methodology and NIST 800-88 to clear a device, including any devices or other media used for backup storage, or otherwise render the content unavailable. All customer content shall be removed or rendered inaccessible. When it comes to customer data privacy, service providers should adopt the following best practices:

- Video security cameras capable of recording all activities that take place at repair workstations in all Retail Environments with appropriate notice to individuals that recording is occurring
- Processes that limit how often, and to what extent, technicians should access customer content to test functionality
- Processes that require any device handling to be done at a repair workstation, or in the presence of the customer in a customer-facing area
- Any removable storage for example, an SD card or SIM card, must be accounted for at all times, and not removed from the device
- Documentation for master reset completion, SD and SIM card and/or main board destruction, for abandoned devices

3.12 Lost and Stolen Devices

It is recommended that the device IMEI be checked against a database of lost or stolen devices. There are several providers of database services including the CTIA Stolen Phone Checker at <https://stolenphonechecker.org>.

In the event a device comes back as “known” lost or stolen, blacklisted or otherwise flagged device, the service provider shall refuse repair service to the customer. The service provider shall not data wipe or alter any software on the device. If the device shows a contact number to call, the service provider shall attempt to contact the number.

Managers are encouraged to contact the authorities to provide information pertaining to the lost or stolen device, but only doing so in a safe manner. No manager or employee should place themselves in harm’s way over a suspected stolen device.

A record of the incident shall be stored in the service provider’s database including the name, phone number, IMEI, device type, and the current carrier service. Other pertinent information regarding the device should be recorded as well.

3.13 Diagnosis and Triage Process

A defined device diagnosis and triage process shall be established and followed. A sample process is provided in [Appendix B](#).

3.14 Safety, Security and Storage

Retail Environments and technicians shall follow industry best practices and make all reasonable efforts to ensure the physical security of materials, products and assets within the retail environment and/or within contractual control boundaries should they extend beyond the retailer’s physical location. Requirements and best practices for security compliance include the following:

- Technicians shall lock devices behind one lock when not in repair during operating hours, two locks when not operating hours
- Retail service providers should enable visibility across the store: maintain shelves low, merchandise neat and consider using corner ceiling mirrors

- Technicians should never leave an open cash register unattended
- Technicians in the storefront shall be vigilant and attentive to customers in the store
- Retail service providers shall utilize cameras and alternative security system features like audio monitor sensors, remote monitoring, and intrusion detection
- Retail Environments shall maintain lighting in all areas of the store, inside and out
- Technicians shall secure storage of parts per employer's guidelines
- Retail service providers shall conduct employee background checks and thorough interviews
- Retail service providers should supervise employee access with electronic access control
- Retail service providers shall educate technicians on work area safety
- Retail service providers shall have an inventory tag management system
- Retail Environments shall have smoke and carbon monoxide detection and notification
- Retail service providers shall follow all state and local legislation applying to fire safety

3.14.1 Handling of Lithium Ion (Li-Ion) Batteries

Precautionary measures and best practices shall be followed when handling devices with Li-Ion batteries. See [Appendix C](#) for guidance.

3.14.2 Employee Emergency Action Plan

A Retail Environment shall have an employee emergency action plan in place.

3.14.3 First Aid Procedures

A Retail Environment and Remote Technician Organization shall have first aid equipment on-hand at all times and documented procedures for handling incidents.

3.15 Point of Sale Minimum Requirements

The Point of Sale (POS) system shall, at a minimum:

- Provide ability to monitor POS transactions in real time through a remote terminal to facilitate training and loss prevention
- Provide access to historical receipts and invoices for print out/email distribution
- Capture IMEIs at time of sale for device tracking purposes throughout the repair process
- Enforce valid entry of IMEI and device serial numbers at time of service transaction
- Ability to view inventory availability during sales order entry
- Visibility of order status by location, region, product, and pertinent customer contact details
- Provide visibility of inventory levels across all products and locations
- Include the IMEI/ESN on invoice line items
- Itemize individual products and services on invoices
- Enforce capture of the IMEI/ESN device returns
- Create customer quotes or estimates, ability to email or print customer quotes or estimates
- A record of a diagnostic test and the results of pre-and post-repair work prior to returning the device back to the customer
- Ability to record whether or not the device is being repaired under a warranty
- Ability to check IMEI history of the device from entry and exit points of the store/company
- Ability to look up a specific customer and see all related transactional history
- Identify the tech assigned to the repair order: ability to identify the technician(s) that executed the repair

- Be PCI compliant

3.16 Reporting Minimum Requirements

The service provider shall ensure that all processes are in place to measure quality metrics such as technicians logged in and out of the system, cycle counts for parts on-hand and customer inventory, measurement of repair quality, tracking rework, bounce rate, and repair turnaround time.

Product and parts traceability and tracking shall be well defined, visible and evident throughout the repair process. All reporting shall be tracked at the device IMEI level, not limited to customer complaints, problems found, repair action, used parts, and the date and time stamp from the initial consultation.

3.17 Inventory Management Requirements

The service provider shall have a process to manage parts and materials that includes the following:

- An electronic Enterprise Resource Planning (ERP) system, or equivalent, where products are received and given a unique device identifier
- An exclusive identifier for each technician to track equipment at the technician level, the office level, and the corporate level
- A technician shall be responsible for cycle counting product and conducting customer-requested physical inventories
- Safeguards and inventory controls to ensure assets are logged and managed appropriately
- A corrective and preventive action program to collect and analyze information, identify and investigate product and quality problems, and take appropriate and effective corrective and preventive action to prevent their recurrence

3.18 Management and Employee Review

Quality management practices and procedures are required in order to ensure an excellent customer experience. Leaders and managers shall lead by example. Top management shall ensure that goals are aligned within the organization. Store management shall ensure that the customer experience is positive and the end result is total satisfaction. Constantly improving the customer experience is a company-wide effort.

The service provider shall have an internal auditing process in place to ensure management and employees are following the requirements for maintaining good standing as a certified WISE ASP.

The owner shall have quarterly reviews of management, employees and performance indicators.

3.19 Ongoing Training Commitment

The service provider shall have a documented training program with records of training being performed by qualified instructors.

Managers shall have a process in place to train and review employees on the current certification requirements within 6 months of a published change.

3.20 Risk of Loss

Management shall maintain adequate security for loss prevention control along with a disaster recovery plan and shall, upon reasonable request, provide such plan to CTIA. Notwithstanding the foregoing, the service provider shall be responsible for risk of loss of, and damage to, any products, equipment, software, facilities or other materials in its possession or under its control.

Section 4 Authorization Process

4.1 Application Submission

Please review [Section 2](#) and [Section 3](#) of this document and ensure all requirements can be met. To submit your application, please visit www.wisecertification.com.

4.2 Application Review

CTIA will review the application and determine whether it sufficiently meets the requirements. Any deficiencies or questions will be identified and communicated to the applicant for resolution in reasonable time.

4.3 Application Acceptance

Once all deficiencies and questions are resolved to the satisfaction of the CTIA onboarding team, the applicant will be notified that the requirements for WISE certification have been met.

4.4 License and Service Agreement

CTIA will provide the applicant with the WISE ASP License and Service Agreement for execution.

4.5 License Fee

The WISE ASP license fee is \$400. CTIA will invoice the applicant for this fee.

4.6 Authorization

Once the License and Service Agreement is executed and the license fee is paid, CTIA will recognize the service provider as a WISE ASP. The service provider will be issued a WISE ASP logo with a unique identifier number, along with digital files for reproduction. The service provider will be listed in the directory of WISE ASPs at www.wisecertification.com.

Section 5 Ongoing Compliance Requirements

5.1 Notification of Material Financial or Management Changes

The ASP shall promptly notify CTIA at programs@wisecertification.com of any material change in its financial condition, management, or control/ownership of a majority of its outstanding equity.





5.2 License and Service Agreement Renewal





The WISE ASP License and Service Agreement shall be renewed on an annual basis. CTIA will provide a license renewal agreement for execution.

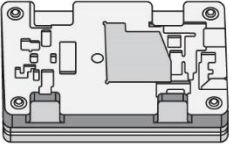
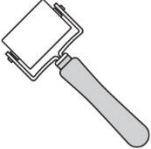
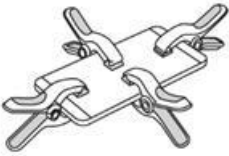

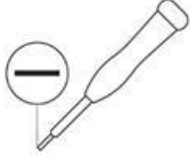

5.3 License Renewal Fee



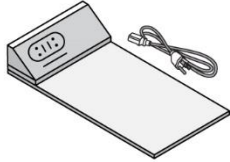

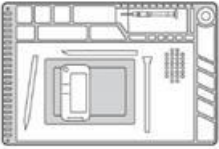
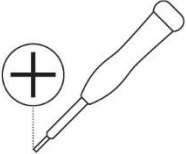
The annual WISE ASP license renewal fee is \$400. CTIA will invoice the ASP for this fee.

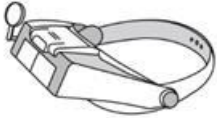

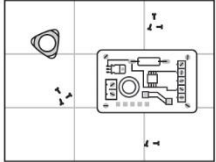

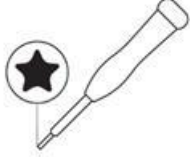
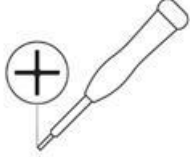

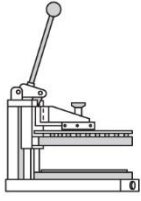
Appendix A Required Tools

Tool	Description	Image
Adhesive	Adhesive is used to replace components previously secured with adhesive. All adhesives are not equal and most are not designed for liquid nor dust resistance. Technicians should be mindful when performing repairs with aftermarket adhesives.	
Alcohol and Solvents	Alcohol and solvents are often needed as cleaners and adhesive removers. Solvent pumps help to store and efficiently dispense many solvents.	
Alignment Jig	An alignment jig is a custom-made tool used to control the location and/or motion of parts or other tools. This tool is required for Retail Environment only.	
Battery Hand Roller	A battery hand roller ensures batteries are fully adhered to the surface during installation.	
Clamps	Clamps are used to provide force after new adhesive is applied to install components during the repair process.	
ESD Safety Equipment	ESD safety equipment, such as wristbands and anti-static mats, is critical to help prevent the occurrence of ESD, which can damage the smartphone during repair.	

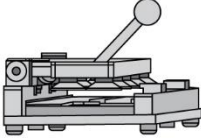
Tool	Description	Image
Eye Goggles	When repairing smartphones there is always the risk of stray screen glass flying off and hitting the face or entering the eye. It is therefore necessary to wear eye protection to shield from such debris.	
Flat-Head Screwdriver	The flat-head screwdriver is used minimally during smartphone repairs. Some technicians find it useful in helping to extract screws, using it to pry up on the screw head.	
Gloves	Gloves are necessary to protect the hands during the device disassembly and reassembly process. They protect from shards of glass from cracked screens and warm components within the device. They also prevent transfer of residues, fingerprints or naturally occurring oils on the technician's hands.	
Guitar Picks	Guitar picks are useful for a variety of tasks including separating, spacing, and prying the components of a device.	
Heat Gun	Heat guns are generally used to soften adhesives for removal during device disassembly. For best practices, a temperature-controlled heat gun is ideal or a heatgun restricted to 80° C.	
Heat Mat	The heat mat is used primarily as an alternate method to heat up a glass surface when no screws are present to open a device. This is frequently necessary with back glass on smartphones.	

Tool	Description	Image
Heat-Resistant Mat	The heat-resistant mat is an excellent way to keep a workspace organized and clean, providing space for tools and small parts.	
JIS Screwdriver	The JIS screwdriver resembles the Phillips screwdriver but is made to the Japanese Industrial Standard (JIS) B 4633 specification. JIS screws are most often identified by a dimple or an X on the screw head. Even though the JIS and Phillips screwdrivers look similar, they are two different designs and are not meant to be interchangeable.	
LED Desk Lamp	Adequate lighting is essential to allow the technician to see clearly while performing a repair. An LED desk lamp is quite useful, especially in environments with inadequate lighting.	
Lighted Headset Magnifier	Smartphone repairs involve many small parts. A lighted headset magnifier allows the technician to see clearly, so each part is visible during the repair process.	
Lipo Bag	Lipo bags are used for safely transporting, storing and charging Li-Ion batteries. The bag has an inner lining made from a woven fire retardant fiberglass material, which helps contain and greatly reduce any fires inside the bag.	
Magnetic Mat	During a repair, it is imperative to stay organized and keep all parts of a device, such as screws and panels, separated for re-installation. A magnetic mat will secure these parts so that nothing will roll away or get lost.	

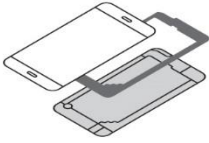
Tool	Description	Image
Magnetizer/ Demagnetizer	<p>The Magnetizer/Demagnetizer is used for magnetizing and demagnetizing screwdriver tips and the screws removed from devices.</p> <p>Some screws are magnetized and may stick together after taken out. This tool allows for a demagnetization of the screws.</p>	
Pentalobe Screwdriver	<p>The pentalobe screwdriver is typically used to take out the two security screws on the bottom of many smartphones.</p>	
Phillips-Head Screwdriver	<p>The Phillips screwdriver is used to remove and install Phillips-head screws.</p>	
Precision Knife	<p>A precision knife can be used for tasks requiring precise cutting. For example, cutting new adhesive for the back glass of a device or opening repair parts packaging.</p>	
Press Fixture	<p>A press fixture creates mechanically and electrically stable connections without the need for additional fastenings, soldering or thermal stress.</p> <p>This tool is required for Retail Environment only.</p>	
Pry Tool	<p>Pry tools are useful for screen repairs. The pointed end is used for entry, and the flat edge is used for leverage to lift the screen up. This tool may be metal or plastic.</p>	

Tool	Description	Image
Removal Fixture	<p>Removal fixtures can be used in place of suction cups or pry tools to remove a display. It uses four suction cups to gently pry the display from the body and provides quicker access to the inside of the device without putting components at risk in the process.</p> <p>This tool is required for Retail Environment only.</p>	
Separation Tool	<p>As a best practice, a removal fixture should be used to separate surfaces (e.g., back housing, batteries and other smooth surfaces). When a removal fixture is not available, a separation tool can be used. A separation tool combines the effect of suction cups and a clamp in order to separate surfaces.</p>	
Spudger	<p>The spudger is one of the most useful tools for a repair technician. It is used for tasks such as gently prying up cable connections, motherboards, and headphone jacks.</p>	
Suction Cups	<p>Suctions cups provide effective grips for raising surfaces including back housings, batteries and other smooth surfaces.</p>	
Thermal Spreader	<p>A thermal spreader is film composed of carbon-like materials such as graphite that acts as a heat distribution component.</p>	
Tool Bag	<p>For remote technicians especially, a tool bag is recommended to keep tools and equipment together and localized within reach.</p> <p>This item is required for Remote Technician Organization only.</p>	

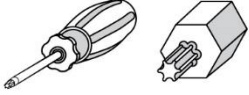
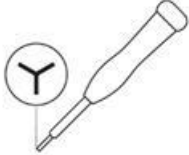
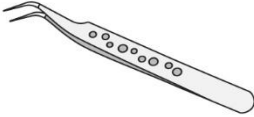
Tool	Description	Image
Torx-Head Screwdriver	The Torx-head screwdriver has a 6-point star-shaped head and is used to remove Torx® screws. By design, Torx-head screws resist cam-out better than Phillips-head or flat-head screws.	
Tri-Point (Y000) Screwdriver	The tri-point, or Y000, screwdriver is used to remove the panel in the iPhone® 7 and 7 Plus that covers the battery connection and screen connections, and the panel cover to the home button flex cable.	
Tweezers	Tweezers are useful for holding and manipulating small parts and components.	

Appendix B Sample Diagnosis and Triage Process

B.1 Pre-Diagnosis

Each service provider has its own approach to customer service. Collecting sufficient information from the customer is critical to providing the best repair service to the customer. Upon initial intake of the device, the technician should ask the customer a standard set of questions to ascertain the condition of the device. The more information the technician can collect, the better he will be able to serve the customer.

B.1.1 Customer Service Best Practices

The following are general customer service best practices:

- Build a rapport with each customer
- Identify a repair solution that meets the customer's needs
- Educate, inform and update customers on the service provider's products and services
- Input all customer information or device information into the assigned point of sale system
- Inform customers of service terms and conditions prior to performing recommended solutions
- Keep detailed records of work order notes for all services requested, identified and provided throughout the repair process
- Maintain workmanship, quality standards and service expectations
- Maintain industry and product knowledge
- Maintain a clean, functional environment that abides by WISE Certification standards

B.1.2 Customer Inquiry

As a part of the pre-diagnosis process, the technician should ask the customer the following questions upon intake of the device:

- What are you experiencing with your device?
- What do you suspect is wrong?
- What was happening when this issue arose?
- Is there any history of liquid damage?
 - What kind of liquid was the device exposed to?
 - Was the device submerged in water or other liquid? If yes, for how long?
 - When did the event occur?
 - Did you try drying the device out? If so, how?
 - Did you try plugging it in or turning it on?
 - Was there any sign of life after the liquid damage? If so, for how long?
- Is there a history of any issues with the device?
- Did you recently perform a software update?
- Were you having battery issues? Did you experience issues charging the device?
- Was the device heating up? Was it exposed to extreme cold/heat?

The technician should note any other significant information provided by the customer or information discovered about the device during the initial intake process.

B.2 Common Repairs

Both Level 1 and 2 technicians are responsible for properly diagnosing the device during the triage process. The following are common repairs, designated for Level 2 technicians that may need to be performed based on the customer's expressed issues:

B.2.1 Display Assembly

The display assembly will potentially need to be replaced if the customer's expressed issue is:

- Device will power on but nothing shows on the screen at all
- Cracked or shattered glass
- Touch functionality on the screen is not working properly
- Display looks like it has ripples
- Images look to be burned into the screen
- Display is a distorted image
- Display has blacked out squares (dead pixels)
- Display has gray lines, horizontal or vertical
- Display is dimmer than it should be
- Bruising on the display, pressure mark
- Thermal damage
- The device does not light up or go dark (proximity sensor)
- Glass and display seem to be separating at the frame
- Air bubbles in the glass
- Debris in the glass

B.2.2 Battery Replacement

The battery will potentially need to be replaced if the customer's expressed issue is:

- Device will not hold charge for expected time
- Device will not charge when connected to OEM charger
- Device makes sudden drops in charge
- Device will not power on
- The device looks like it has a gap between the frame and back cover
- The device looks like it has some swelling

B.2.3 Headphone Jack Replacement

The headphone jack will potentially need to be replaced if the customer's expressed issue is:

- Crackling noise in the headphones or earbuds, external accessories
- An object stuck in the headphone jack or debris inside
- No sound at all when plugged into headphones, earbuds or external accessories

B.2.4 Camera Replacement

The camera, front or rear, will potentially need to be replaced if the customer's expressed issue is:

- Camera app will not open
- Cracks or scratches on the lens

- Debris on the lens
- Camera is not showing correct colors
- No function at all

B.2.5 Power and Volume Cable and Buttons Replacement

The power/volume cable or external power/volume buttons will potentially need to be replaced if the customer's expressed issue is:

- No audio
- Volume will not increase or decrease
- Buttons stuck
- Button is damaged or missing
- Device will not power on/off

B.2.6 Mute and Silent Switch Replacement

The mute/silent switch will potentially need to be replaced if the customer's expressed issue is:

- Button is damaged, stuck or missing
- Device will not go into silent mode

B.2.7 Replace Component Cable

The Wi-Fi component/antenna may need further diagnosis if the customer's expressed issue is:

- The device will not connect to Wi-Fi

B.2.8 Home Button Replacement

The home button will potentially need to be replaced if the customer's expressed issue is:

- Stuck button
- Cracked, scratched button
- No response when pressed (*Touch ID not detected*)

B.2.9 Charging Port Replacement

The charging port will potentially need to be replaced if the customer's expressed issue is:

- Device is not charging properly or only intermittently when using appropriate OEM charging accessory
- Debris or object stuck inside the charging port
- Damaged or broken from accessory use

B.3 Upon Receipt of Device

B.3.1 Perform Visual Inspection

- a) Cosmetic: All surfaces as defined in [1] CTIA Wireless Device Grading Scales Criteria and Definitions.

- b) Connectors and ports including USB port, headphone port, speakers and microphone: Inspect for dust/debris and or signs of liquid intrusion.
- c) Glass/Display: Inspect for signs of physical damage such as lines, fractures, de-lamination and/or water or other liquid damage spots.
- d) Frame: Check the frame of the device for cracks or breaks, signs of wear, and cosmetic damage.
- e) Back Door (If applicable) – Check the back door for cracks.

NOTE: Damage to the frame or glass/display caused by a drop could damage internal components and/or cause loose connections.

B.3.2 Perform Liquid Damage Inspection

A device with liquid damage can first be detected with externally visible liquid damage inspection (LDI) at which point the customer should be notified. If authorized by the customer, open the device to search for further signs of corrosion, which can confirm the damage.

B.3.2.1 External Inspection

- a) Inspect externally, looking for corrosion at the following:
 - o USB, headphone jack, HDMI, SIM port, SD memory port and any other applicable port
 - o Housings, buttons, rear housing, display and any other applicable part of the housing
 - o Battery, battery connectors, battery contacts, battery doors and any other part associated with the battery
- b) Inspect external LDIs. If any are triggered and there is not EXTERNAL corrosion, the device should be opened to ensure there is INTERNAL corrosion.

B.3.2.2 Internal Inspection

- a) Inspect internally, looking for corrosion at the following:
 - o PCBA, shields, internal connectors, antennas, external ports, PCBA connections and all PCBA related components
 - o Internal housing, buttons, back of display and all internal housing associated parts
 - o Battery, battery connectors, battery contacts, battery doors and any other part associated with the battery
- b) Inspect internal LDIs. If any are triggered or there is internal corrosion, the device has liquid damage.

B.4 Pre-Test Documentation

The technician should thoroughly document the results of the customer inquiry, visual inspection and liquid damage inspection. Requirements may vary by service provider. It is the technician's responsibility to understand his employer's process.

Notes should be as detailed as possible, allowing any technician processing the unit to easily determine what is wrong with the unit. A technician should know the exact condition of the device at their workstation and any technician should be able to inform the customer of the device's condition

from the detailed notes. Technicians rely on documented notes to efficiently repair the device. This reduces miscommunication, overlooked questions and follow-up calls. It also reduces the possibility of the service provider being held responsible for unrelated damage to or issues with the device.

B.5 Checking Functionality

When testing device functionality, it is recommended that all tests be performed utilizing the OEM's onboard diagnostics tool or an OEM-certified remote test application.

Upon completing functional testing, it is best practice to power cycle the device and or perform a soft reset to address issues such as frozen screen, overheating and delayed touchscreen response. Data on the device will not be deleted when performing a soft reset.

When wiping a device of anything imported, added or installed, a technician may perform an internal or external data reset. Procedures for both techniques will vary depending on the operating system and device model. With customer authorization, a technician can perform a standard reset by searching for factory data reset options under Settings. If a technician is unable to access the device's menu to perform the standard reset, a technician can perform an external reset. When performing an external reset, everything is removed from the device.

The technician should also verify the device is operating on the latest software version. OEMs will include "bug fixes" that may address the customer's issues. Examples include, but are not limited to, power cycling, overheating, delayed touchscreen response and not charging. If the latest version is unknown, please refer to the OEM's website.

B.5.1 Charging

- a) Ensure that there is nothing blocking the charge port, such as lint or other debris.
 - Before cleaning, ensure the phone is off. If foreign material is present in the USB connector, use a small brush with nylon bristles to loosen the foreign material and then blow it off with compressed air. If further cleaning is needed, add a few drops of alcohol, allow alcohol to sit for 30-60 seconds, brush it off, rinse with alcohol and allow a few minutes to dry. Repeat if necessary.
- b) Using a known good USB and power adaptor, test that the device charges when it is plugged in. It is recommended to test the charging mechanism with an OEM charger and USB cable to ensure correct voltage is being applied.

B.5.2 Display

- a) With the device on, test that the display has no lines, bright spots, dead pixels, fading or cracks. If the display exhibits any of these issues, this indicates an issue with the display.

B.5.3 Digitizer and Touch

- a) Open the camera application on the device and drag the focus across the screen. If the focus fails to follow the touch, this can indicate failure of the digitizer in either localized spots or as a whole.
- b) Test that the digitizer is not ghosting.
 - If the screen moves on its own or opens apps, this is indicative of ghosting.

B.5.4 Buttons

B.5.4.1 Power

- a) Test that when the button is pressed, the corresponding function is triggered. The button should not be binding or restricted from movement when pressed.

B.5.4.2 Volume Up and Down

- a) Test that when the button is pressed, the corresponding function is triggered, and the keys move freely. They should not be binding or restricted from movement when pressed.

B.5.4.3 Vibe

- a) The vibe key should move freely without binding or restriction in any way. You may also notice the vibrate motor engage during testing.

B.5.4.4 Home Key and Button

- a) Test that when the button is pressed, the corresponding function is triggered. The key/button should move freely and not be binding or restricted from movement when pressed.

B.5.4.5 Keypad

- a) Test that when the key is pressed, the corresponding function is triggered, and the key moves freely. The keypad should not be binding or restricted from movement when pressed.

B.5.5 Vibrate Motor

- a) Test that when the device is called while in silent mode, the vibrate motor is triggered.
- b) The vibrate motor can be manually triggered on some devices by turning the silent switch to the ON position or turning the ring volume off.

B.5.6 Wireless Capabilities

B.5.6.1 Cellular

- a) When the device is on, check the indicator on the top of the screen to confirm that the device is receiving service.
- b) With a SIM card: If the device does not show service with a known working SIM card installed, this can indicate an issue with the antenna or the coax cable connections on the system board.
- c) Without a SIM card: If there is no SIM card in the device, the technician cannot give a definitive answer to the status of the service.
- d) A network simulator may also be utilized to test the cellular connection. This is typically done in high-volume service centers.

B.5.6.2 Wi-Fi

- a) Test that the device can connect to Wi-Fi using a local access point.
- b) If the device cannot connect to Wi-Fi, this may indicate an issue with the Wi-Fi antenna, operating system or coax cable connections on the system board.

B.5.6.3 Bluetooth

- a) Test that the device is visible and can connect to a Bluetooth capable device.
- b) Confirm that the Bluetooth enabled device is powered on and functioning properly.
- c) If the device cannot connect, it may indicate an issue with the Bluetooth antenna, operating system or coax cable connections on the system board.

B.5.7 Camera

B.5.7.1 Front Camera Photography

- a) Test the front-facing camera by opening the camera application on the device and switching between the front and back cameras.
- b) If the camera fails to open, the image appears hazy or it stops responding, this may indicate an issue with the camera software or hardware.
- c) Point the camera toward the test image (a color wheel or similar).
- d) If equipped with zoom function, test this using the zoom controls to ensure the image in the display changes according to the control inputs.
- e) If equipped with auto-focus, move the device away from and toward the test image and observe if the camera is quickly (within seconds) refocusing on the test image.
- f) Reset the zoom to 1:1 (no zoom), point the camera at the test image and adjust the distance to fill the display with the test image.
- g) Take a picture of the test image.
- h) Check the image for proper focus, sharpness, white balance and presentation of primary colors, brightness, perspective, cold and/or hot pixels, fuzzy or distorted areas. Poor results in any of these elements may indicate a camera hardware issue.
- i) Delete the image.

B.5.7.2 Rear Camera Photography

- a) Test the rear-facing camera by opening the camera application on the device and switching between the front and back cameras.
- b) If the camera fails to open, the image appears hazy or it stops responding, this may indicate an issue with the camera software or hardware.
- c) Point the camera toward the test image (a color wheel or similar).
- d) If equipped with zoom function, test this using the zoom controls to ensure the image in the display changes according to the control inputs.
- e) If equipped with auto-focus, move the device away from and toward the test image and observe if the camera is quickly (within seconds) refocusing on the test image.
- f) Reset the zoom to 1:1 (no zoom), point the camera at the test image and adjust the distance to fill the display with the test image.
- g) Take a picture of the test image.
- h) Check the image for proper focus, sharpness, white balance and presentation of primary colors, brightness, perspective, cold and/or hot pixels, fuzzy or distorted areas. Poor results in any of these elements may indicate a camera hardware issue.
- i) Delete the image.

B.5.8 Video

B.5.8.1 Accelerometer-Gyroscope Verification

- a) From the Home Screen, enable the camera application.
- b) Point the rear camera at an object.
- c) With the device in hand, turn it to the left 90 degrees and verify that the icons rotate with the device.

B.5.8.2 Rear Camera Video

- a) Select Video to place the device in video mode.
- b) Tap the Flash icon. Select On. Focus on an object.
- c) Tap the video record icon and then say, "Test 1, 2, 3," while the device is recording. Verify that the flash works.
- d) Tap the Stop icon to stop the recording.
- e) Playback the video and check for any audio or visual distortion.
- f) Delete the video.

B.5.8.3 Front Camera Video

- a) At the Camera screen, tap the Reverse Camera icon, then point the front camera at an object.
- b) Tap the Video record icon, then say, "Test 1, 2, 3," while the device is recording.
- c) Tap the Stop icon to stop recording.
- d) Playback the video and check for any audio or visual distortion.
- e) Delete the video.
- f) Verify all the media taken during camera and video testing has been deleted.
- g) Return to the Home Screen.

B.5.9 Biometric Security

B.5.9.1 Fingerprint and Touch ID

- a) If this is a customer device, the Touch ID is enabled and the device is in a working state, have the customer test the Touch ID to confirm functionality.
 - This is important because the technician cannot test the Touch ID themselves.
 - If the customer has already departed the location, the technician can test the functionality of the device by attempting to access the device via Touch ID. The technician will not be able to access the device, but if the scanner reads the fingerprint and denies access, the functionality can be verified as working.
- b) If this is NOT a customer device, proceed to settings and follow the steps to set up a Touch ID to confirm the Fingerprint/Touch ID sensor is working properly.

B.5.9.2 Facial Recognition

- a) If this is a customer device, the Facial Recognition is enabled and the device is in a working state, have the customer test the Facial Recognition to confirm functionality.
 - The technician must not test the Facial Recognition themselves.
 - If the customer has already departed the location, the technician can test the functionality of the device by attempting to access the device via Facial Recognition. The technician will not be able to access the device, but if the device denies access and requests another form of verification, the functionality can be verified as working.
- b) If this is NOT a customer device, proceed to settings and follow the steps to set up Facial Recognition to confirm the Facial Recognition feature is working properly.

B.5.10 Headphone Jack

- a) Test that the headphone jack works correctly by plugging in a set of headphones and listening to the sound feedback from a YouTube video or video recorded during the video test.
- b) If the headphone jack fails to allow sound, crackles or cuts out when the wire is moved, this may indicate that there is physical damage to the headphone jack.

NOTE: In some cases, the headphone jack and charging port are one and the same.

B.5.11 Ear Speaker

- a) Test the ear speaker of the device by making a test call or, alternatively, making a voice recording and playing it back. It is highly important to remember to delete the recording at the conclusion of the test.
- b) If the ear speaker crackles, cuts out or does not work, this may indicate debris in the speaker or microphone, or an issue with the earpiece speaker itself, the connectors or the contacts on the system board.

B.5.12 Loudspeaker

- a) Test the loudspeaker of the device by making a test call or, alternatively, making a voice recording and playing it back. It is highly important to remember to delete the recording at the conclusion of the test.
- b) If the loudspeaker crackles, cuts out or does not work, this may indicate debris in the speaker or microphone, or an issue with the loudspeaker itself, the connectors or the contacts on the system board.

B.5.13 Proximity Sensor

- a) Test the proximity sensor by making a test call. While the call is in progress, move the device away from your face. With a free hand, cover the front of the device near the front facing camera. If the screen of the device darkens, this shows that the proximity flex is working correctly.
- b) If the proximity flex is not working correctly, the screen of the device will not darken, or will sporadically cut off and on while the call is in progress.
- c) With certain devices, an issue with the proximity sensor may be indicative of a problem with the front camera flex (the location of the proximity sensor).

B.5.14 Microphone

- a) Test the microphone of the device by making a test call or, alternatively, making a voice recording and playing it back. It is highly important to remember to delete the recording at the conclusion of the test.
- b) If the microphone crackles, cuts out or does not work, this may indicate debris in the speaker or microphone, or an issue with the microphone itself, the connectors or the contacts on the system board.

B.5.15 Accelerometer-Gyroscope

- a) Test the internal accelerometer and gyroscope of the device by turning off all orientation locks and holding the device in landscape mode, once on each side.
- b) If the device does not reorient, ensure that orientation locks are off. If the issue persists, this may indicate a software issue or internal hardware issue.

B.5.16 Battery

- a) Test that the device can successfully turn on.
- b) If the device cannot turn on and shows no indicator that it needs a charge, this can indicate a problem with the battery or the display. Next, check for key tones. If key tones are present but there is no display, this is an indication the display may need to be replaced or has a loose connection.

B.5.17 Device Software

- a) Go into the system settings and check to see if the system software is up to date. If the software is not up to date, the technician may request that the customer upgrade to the latest software. If the customer refuses to upgrade to the latest software, it is recommended that the technician refuse repair on the device.
- b) If the device is experiencing a specific issue related to software, the technician should conduct research, by consulting the manufacturer's website or internal knowledge base articles, to see if an update to the operating system addresses the issue.

NOTE: Software services, repairs and upgrades should only be performed as requested by the customer. Technicians should not be responsible for data loss or data backups. When providing a service or repair that requires the installation of diagnostic software or any other necessary software to perform the required service, the technician should obtain customer approval. Non-authorized software should never be used during the repair process.

B.5.18 Device Hardware

- a) Physical abuse may result in damage to internal components, which should be checked for damage or loose connections during the repair process.

B.5.19 Viruses and Malware

- a) Ask the customer if there is a recently downloaded app this is malfunctioning or any apps on the device they do not recognize. If so, ask the customer to delete those apps.
- b) Restart the device.

B.6 No Fault Found (NFF) and No Trouble Found (NTF)

An NFF (No Fault Found) and NTF (No Trouble Found) is a device that has passed basic functionality testing and works as designed. A standard best practice should be followed when trouble is not found or cannot be replicated.

B.6.1 Process to Determine NFF and NTF

The following quality control process should be followed to determine NTF/NFF:

- a) Perform non-intrusive testing
- b) Perform basic functionality testing
- c) Perform battery testing
- d) Determine if external device/software is accessible/applicable
- e) Perform modular component testing through additional parts/swaps/use of test devices
- f) Perform board-level component testing
- g) Breakdown of tests and inspections performed to be able to supply the customer with info

B.6.2 Level 1 Technician

- a) Perform basic functionality testing
- b) Perform battery load testing
- c) Perform battery health testing using battery help and status tool
- d) Perform cellular signal strength testing
- e) Perform Wi-Fi and Bluetooth connectivity testing

If NFF/NTF, the technician should report this to the customer. If the customer desires further testing, this should be conducted by a Level 2 Technician.

B.6.3 Level 2 Technician

- a) Test of each internal modular component using basic diagnostics/troubleshooting procedures
- b) Use external battery test box (if available)

If NFF/NTF, the technician should report this to the customer.

B.7 Post-Repair Functional Test

Once the unit has been repaired, it is recommended that the technician perform a functional test of the device. The device should be fully functional and pass all points of inspection. If a functional fail is identified during this process, which was not previously noted, the technician should continue performing work on the device to rectify the issue.

B.8 Post-Repair Documentation

The results of the repair and the post-repair functional test should be thoroughly documented. Following are examples of notes that could be taken during these stages of the process:

- Screen repair was successful; there were no additional issues found
- The frame/corners were not allowing the screen to sit properly; additional components need to be replaced in order to successfully complete the repair
- There was no sign of liquid damage
- The battery efficiency in this device is at (X) percent (would recommend replacing OR battery is good)
- New (name of part) installed
- Replacement part on order and estimated time of arrival
- Device passed all post-repair functional testing procedures
- Called customer and left a message to inform that the device is ready for pickup, hours of operation, and cost if any

Appendix C Guidance for Handling Lithium Ion Batteries

When handling devices with Li-Ion batteries, it is imperative to take basic precautionary measures and follow best practices. This guidance does not contain device-specific training procedures. Please refer to organizational or OEM training materials for device-specific battery replacement procedures.

Batteries that are swollen and/or have a crease, dent, puncture, or other deformation shall be removed and replaced with a new battery. These batteries shall not be reused.

C.1 Background

Like many consumer electronics devices, smartphones contain Li-Ion batteries and sensitive electronic components that are designed to be serviced by qualified technicians. Li-Ion batteries are a safety-critical component of these devices.

Li-Ion batteries can combust if punctured, bent, dented, or damaged. Basic best practices can minimize incidents with Li-Ion batteries.

Properly train technicians. Technicians who perform smartphone repairs shall be properly trained and provided with the appropriate tools, components, and work instructions. Careless work during a repair, or the use of improper components, can lead to safety risks including battery thermal events.

Run available service diagnostic. Testing for charge capacity, cycle count, and battery health are essential first steps when servicing suspected battery issues.

Work carefully to protect the battery. The batteries used in most modern smartphones are contained in a soft pouch protected by the outer enclosure of the device. When the device enclosure is opened for a repair, the battery can be damaged by tools or other components making contact with the battery. Damaging the battery can create a safety risk.

It is recommended to replace a soft pouch battery that has been removed from a device, as the removal process is potentially damaging to the battery. A removed battery, including those "harvested" from other devices, does not provide the same guarantee of quality and safety as a new battery.

Use the highest quality components/batteries available along with proper tools.

Look for loose screws or components. Any repair requiring the removal of screws or other components must be carefully performed to ensure that loose screws or misaligned components are not left inside a device. Loose screws or misaligned components can damage the battery and potentially lead to a battery thermal event.

Check your work. Appropriate final testing according to each organization's own internal standards shall be done to assure the quality and safety of any repair job.

C.2 Battery Service: Recommended Equipment

The service provider shall possess the following equipment for working on Li-Ion batteries:

- Nitrile/latex gloves
- Heat-resistant gloves
- Safety glasses
- Cleaning wipes (to clean safety glasses)
- 8–10 cups of clean, dry, untreated sand, stored in a container as specified below
- Wide-mouth non-breakable plastic quick-pour sand container with a flip-top lid

- The sand container shall be within arm's reach (2 ft. or 0.6 m), on either side of the workstation, for immediate access during an unexpected thermal event. It shall not be stored above or below the workstation.
- Hand broom with dust pan
- Existing ESD bags or re-sealable, plastic disposal bags, and boxes
- Yellow fire-proof safety cabinet
- Lipo bags
- ABC fire extinguisher
- Voltmeter

C.3 Battery Service: Safety Precautions, Training and Handling Guidelines

The service provider shall follow these precautions and guidelines when working on Li-Ion batteries:

- Wear safety glasses whenever handling batteries.
- Remove jewelry items such as rings, wristwatches, pendants, etc., that could come in contact with the battery terminals.
- Always inspect Standard Operating Procedure (SOP) prior to disassembly to ensure the proper temperature guidelines are followed when disassembling devices.
- All swollen, creased, dented, punctured, or otherwise deformed, batteries shall be processed in accordance with appropriate SOP.
- Always have all safety equipment available (ABC fire extinguisher, fire safety gloves and dedicated Li-Ion containment container with sand) when disassembling or processing devices with internal soft-pouch batteries.
- Cover all metal work surfaces with an insulating material (ESD mat). Work areas shall be kept clean and free of metal or sharp objects that could short the contacts, puncture or damage the cover to the battery.
- All tools shall be made of ESD material with no sharp edges in order to prevent dents and punctures.

C.4 Battery Safety Training

Every technician handling batteries, regardless of their skill level, shall complete battery safety training that includes the best practices described here.

C.4.1 Battery Handling

The service provider shall follow these key handling and safety points when working on Li-Ion batteries:

- Do not subject batteries or battery-powered devices to high levels of force
- Excessive force shall not be used to free a battery lodged inside the housing
- Check for proper fit before inserting the battery into any type of housing
- Batteries shall not be forced into the battery cavity
- Do not expose Li-Ion batteries to liquids
- Only use inspection tools (such as calipers and rulers) that are made from, or covered with a non-conductive material
- Properly connect the battery in the electronic device, charger, or testing equipment
- Use only certified chargers. Non-certified chargers may over-charge a battery, causing swelling.

- Discharge battery only in an approved device
- Do not short circuit the battery
- Do not directly solder a battery
- Never attempt to open a battery
- Never attempt to repair a battery
- Remove batteries from a device that will not be used for an extended period of time (if possible)
- Do not reuse soft-pouch batteries
- If something unusual is noticed, stop using the battery. If the battery or battery-powered device gives off an unusual odor, overheats, vents, sparks, is discolored, deformed or reacts unusually in any way during use, recharging or storage, remove it from the device or battery charger and discontinue use.
- Never use a battery if it is:
 - Swollen
 - Dented
 - Creased
 - Punctured
- Keep metal tools away from batteries
- Never use water to put out a battery fire

C.4.2 New Battery Installation

The service provider shall follow this guidance when working with new Li-Ion battery assemblies:

- Always use new battery adhesives. Reusing the adhesive left on the housing could lead to the battery coming loose and may cause safety issues.
- Ensure the residue left on the housing gets completely clean isopropyl alcohol before placing new adhesive.
- Never place a new adhesive on top of a current one since it increases the height and could cause interference with the internal space.
- Ensure proper alignment of the adhesive to the housing surface is critical for proper bonding strength.
- Ensure proper use of press and hand roller so that adhesive properly bonds to the housing and battery. Insufficient bonding may cause the battery to loosen resulting in safety issues.
- Some batteries may require adding pads and tape after assembly; ensure those are not skipped.
- Inspect the housing to ensure no sharp edges contact the battery.
- Inspect battery flex or cable for signs of damage.
- Inspect the connectors on the battery flex/cables and board to ensure they are not damaged.
- Proper alignment of the battery to the housing surface is critical for safety.
- Do not place labels on the battery unless required by the OEM.
- Ensure the battery connector is properly connected to the board.

C.4.3 Storage Guidelines

The service provider shall follow these Li-Ion battery storage guidelines:

- Store batteries in a well-ventilated, dry area. The temperature shall be as cool as possible to maximize shelf life.

- Keep away from temperatures below -4° F and above 113° F (-20° C | 45° C).
- Li-Ion batteries function best in the temperature range of 32° to 95° F (0° to 35° C)
- Store batteries in an isolated area, away from combustible materials and preferably in a fireproof safety container.
- Store batteries in their original protective cases, padding, and boxes.
- Store batteries in a separate location from new batteries.
- Make sure to place only one battery in each box.
- Any Li-Ion battery storage area shall have immediate access to an ABC-type fire extinguisher and a Li-Ion battery containment device with sand.
- Never stack heavy objects on top of boxes containing Li-Ion batteries to preclude crushing or puncturing the cell case. Severe damage can lead to internal short circuits resulting in a battery thermal event.
- Minimize the number of Li-Ion battery boxes that are stacked on top of each other.
- Do not allow excessive quantities of batteries to accumulate in any storage area.

C.4.4 Battery Recycling and Shipment

The service provider shall source a recycle provider and adhere to their prescribed shipping procedures. The recycler shall have appropriate certifications including [2] R2, version 2013 or later.

To find R2 recyclers, please see <https://sustainableelectronics.org/recyclers>.

C.4.5 Remote Technicians and Thermal Events

Remote technicians shall carry Lipo bags at all times when performing repairs and a fireproof box available in their vehicle.

Appendix D Revision History

Date	Version	Description
October 2019	1.0	Initial release of document